

## THALAMUS

S. MURRAY SHERMAN AND R. W. GUILLERY

The thalamus is the largest part of the diencephalon, one of the major subdivisions of the brain. Each of these subdivisions of the brain—the *telencephalon*, *diencephalon*, *mesencephalon*, and *rhombencephalon*—forms around one of the major ventricular spaces, and each has a distinctive structure, determined at early developmental stages by regulatory genes that produce distinct patterns of regional specification (Rubenstein et al., 1994, 1998). The diencephalon itself is further subdivided into several distinct parts, which are the *epithalamus*, *dorsal thalamus*, *ventral thalamus*, *subthalamus*, and *hypothalamus*. In this chapter we are concerned with the dorsal thalamus, commonly, as in this chapter, referred to simply as the *thalamus*, and with a part of the ventral thalamus called the *thalamic reticular nucleus*. Each of these parts of the diencephalon develops a distinctive structure. Particularly for the dorsal thalamus, which is, as we shall see, divided into many different subdivisions, or “nuclei,” the common developmental origin has produced a common structural pattern, and this allows us to look at some parts and arrive at generalizations that to a great extent apply to all of the parts.

The dorsal and the ventral thalamus are the two parts of the diencephalon that play a role in transmitting the messages going to the neocortex from the periphery and from the rest of the brain, and it is the organization of the connections with the neocortex that forms the focus of this chapter. There are other pathways that connect parts of the thalamus with the striatum (see Chap. 9) and with the amygdaloid complex (LeDoux et al., 1985), concerned with movement control and affective responses, respectively, but these are not considered further here.

The thalamus provides the major route for afferents to the neocortex (Jones, 1985; Sherman and Guillery, 2001). Essentially no messages can reach the neocortex without first passing through the thalamus. Messages from many different sources pass through the thalamus on the way to the neocortex, including messages from peripheral sense organs (such as vision, hearing, touch, temperature, pain, taste, olfaction), other regions of the brain (such as the cerebellum and the mamillary bodies), and the neocortex itself. In general, each functionally distinct group of messages passes through a distinct part of the thalamus, identifiable as a well defined cell group or thalamic “nucleus.” One finds the same arrangement of inputs, outputs, and synaptic relationships in each of these nuclei, although, as we shall see, there are some differences in the details. We will treat the visual relay in the lateral geniculate nucleus as a prototype of

thalamic nuclei. We know that many features demonstrable in the lateral geniculate nucleus are also seen in other nuclei, and the amount of information about the functional organization of the lateral geniculate nucleus is significantly more detailed than that for any other thalamic nucleus.

### THE GENERAL ORGANIZATION OF THE THALAMUS

#### THE MAJOR THALAMIC NUCLEAR GROUPS

The major thalamic nuclear groups of a primate like the macaque monkey are shown schematically in Fig. 8.1.

Two functionally distinct types of nucleus are shown. The first, shown shaded, contain *first order relays* to the cerebral cortex. These carry messages from the periphery or from lower brain centers to the neocortex. They are the thalamic nuclei about which we know the most, but they represent less than one-half of the volume of the thalamus in a primate brain. In order, from rostral to caudal levels, these are as follows: the *anterior thalamic nuclei*, which receive afferents from the mammillary bodies and from the postcommissural fornix and send efferents to the cingulate and retrosplenial cortex; the *ventral anterior and ventral lateral thalamic nuclei*, which receive afferents from the deep cerebellar nuclei and send efferents to the motor and premotor cortex; the *ventral posterior thalamic nuclei*, which have an inferior, a lateral, and a medial part and receive afferents from the medial lemniscus, concerned with limb position, tactile, and deep pressure receptors, and from the anterolateral pathways, concerned with thermal and nociceptive afferents from all parts of the body; the *ventral part of the medial geniculate nucleus*, which receives auditory afferents from the inferior colliculus and sends efferents to the auditory cortex; and the *lateral geniculate nucleus*, which receives afferents from the retina and sends efferents to the visual cortex.

The nuclei that are unshaded in Fig. 8.1 all represent nuclei that contain *higher order relays*; that is, they all receive incoming messages from the cortex itself and relay these messages from one cortical area to another. These nuclei include the *mediodorsal nucleus*, which, in addition to inputs from olfactory cortex and from the amygdaloid complex, receives afferents from frontal cortex and sends efferents to the frontal cortex, linking one part of frontal cortex to another; the *laterodorsal nucleus*, which probably receives afferents from cingulate cortex and sends efferents back to cingulate

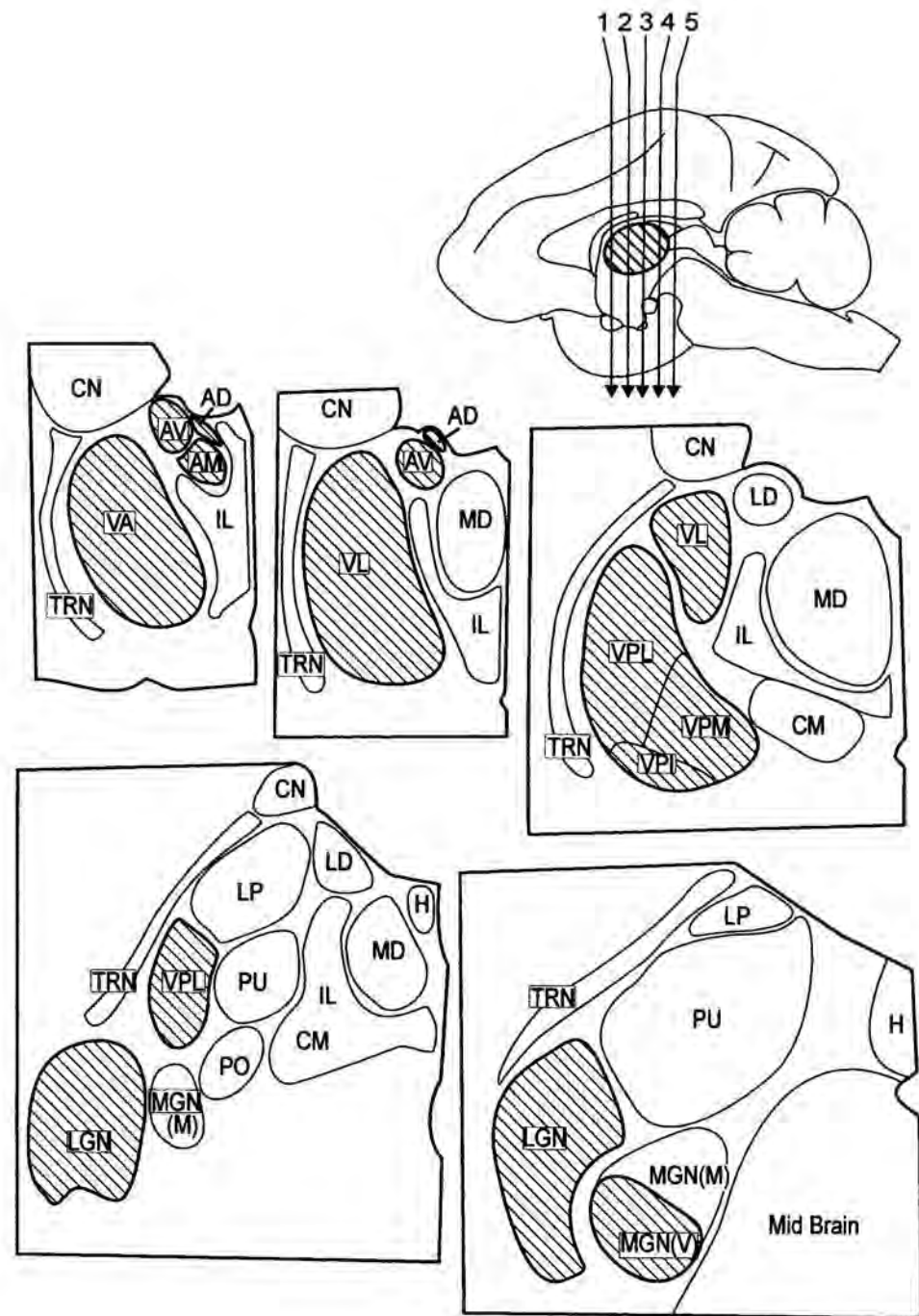

Fig. 8.1. Schematic view of five sections (1 at top left through 5 at bottom right) through monkey thalamus cut in the coronal planes indicated by the numbered arrows in the upper midsagittal view of a right hemisphere. The major thalamic nuclei for a generalized primate are shown. The nuclei outlined by a heavier line and filled by hatching are largely or entirely first order relays, receiving their driving afferents from ascending pathways. The other nuclei are primarily or entirely higher order relays (further details in text), receiving many or all of their driving afferents from layer 5 cells of neocortex. Abbreviations: AD, anterodorsal nucleus; AM, anteromedial nucleus; AV, anteroventral nucleus; CM, centre median nucleus; CN, caudate nucleus; H, habenular nucleus; IL, intralaminar (and midline) nuclei; LD, lateral dorsal nucleus; LGN, lateral geniculate nucleus; MGN(M) and MGN(V), magnocellular and ventral divisions, respectively, of medial geniculate nucleus; PO, posterior nucleus; PU, pulvinar; TRN, thalamic reticular nucleus; VA, ventral anterior nucleus; VL, ventral lateral nucleus; VPI, VPL, VPM, inferior, lateral, and medial parts of the ventral posterior nucleus. [From Sherman and Guillery, 2001.]

cortex, again serving to link one cortical area to another; the *pulvinar region* (we use this term to include the lateral posterior nucleus and the pulvinar in the cat), which serves to link cortical areas of occipital and temporal lobes, and the *intralaminar nuclei*, which represent a mixed group of cells, with some receiving ascending afferents from the anterolateral system (and thus first order) and others receiving afferents from motor cortex and sending their axons to cortex and also to the striatum.

#### THE MAJOR TYPES OF AFFERENT TO A THALAMIC NUCLEUS

In later parts of this chapter (in Drivers and Modulators), we provide functional and morphological details that distinguish afferents that are *drivers* from those that are *modulators* (for details, see Sherman and Guillery, 1998, 2001). The significance of this distinction can be illustrated for the visual relay in the lateral geniculate nucleus. Here we find that fewer than 10% of the synapses on the *relay cells* (the cells concerned with sending messages on to the visual cortex) are formed by axons that come from the retina. The other 90% of the synapses come from visual cortex, from the brainstem, from cells in the thalamic reticular nucleus, and from local, geniculate interneurons. It is clear for this relay that the crucial information conveyed to the visual cortex is the visual information that comes from the retina. Because the lateral geniculate nucleus is demonstrably concerned with transmitting visual information, we can recognize that the retinal afferents must be the drivers. The characteristic response properties of these thalamic cells are lost following loss or silencing of the drivers. Comparable arguments allow us to recognize the lemniscal and anterolateral afferents as the drivers for the ventral posterior nucleus and the afferents from the inferior colliculus as the drivers for the medial geniculate nucleus. The axons that represent these drivers are all similar in their light and electron microscopic appearance, and all establish similar synaptic patterns in the thalamus and share certain functional properties; these patterns are distinct from those formed by all of the other afferents, which are all regarded as modulators (see details in Drivers and Modulators). Silencing a driver to a nucleus abolishes the characteristic receptive field properties of the cells in that nucleus. The modulators, in contrast to the drivers, do not bring the characteristic receptive field properties to a nucleus but, instead, modify the nature of the transmission to the cortex. The degree to which the modulators outnumber the drivers is surprising at first sight but can probably be seen as representing the complexity of the modulation that is possible at the thalamic relay, a complexity that is only partially understood at present.

For nuclei other than the medial and lateral geniculate nuclei and the ventral posterior nucleus, it is less easy to identify the drivers on purely functional grounds. However, we know that the mamillothalamic afferents to the anterior thalamic nuclei and the cerebellar afferents to the ventral anterior and ventral lateral nuclei also closely resemble, in their structure and in their synaptic relationships (see below in The Electron Microscopic Appearance of the Neuronal Elements), the identifiable drivers. Therefore, we regard them as the drivers of these first order nuclei. Similarly, the nuclei shown in Fig. 8.1 as containing higher order relays receive afferents from layer 5 of cortex that resemble the known visual, auditory, and somatosensory drivers (see details in First Order and Higher Order Relays). Whereas the cortex sends modulatory afferents from cells in cortical layer 6 to every thalamic nucleus, only the higher order

relays receive the functionally and morphologically characteristic drivers from cortical layer 5. For some of these higher order drivers, coming from somatosensory or visual cortex, we know that they must be drivers because, when they are silenced, the relevant higher order thalamic relay loses its receptive field properties (Bender, 1983; Chalupa, 1991; Diamond et al., 1992); for others, the critical functional evidence is not available but the morphological relationships provide a strong clue that they, indeed, are drivers (Mathers, 1972; Schwartz et al., 1991).

It has to be stressed that, for many thalamic nuclei, defining the specific properties of the drivers for that nucleus is yet not possible. This is true for many higher order relays and is also true for the cells of the intralaminar nuclei and for the cells that receive cerebellar (and pallidal) afferents. For the anterior thalamic nuclei, there is evidence that they receive messages concerned with head direction in space and with spatial maps from the mamillary bodies (Taube, 1995; Van Groen et al., 2002).

#### PARALLEL PROCESSING

For the visual and somatosensory pathways, there are functionally distinct parallel driver pathways running through, respectively, the lateral geniculate nucleus and the ventral posterior nucleus. For instance, the retinal ganglion cells that innervate the lateral geniculate nucleus fall into several distinct morphological and functional classes that provide parallel streams with minimal interaction through thalamus to cortex (Sherman, 1985). Thus, each of these ganglion cell classes innervates a unique relay cell class in the lateral geniculate nucleus. In the cat, these retino-geniculo-cortical streams are known as the W, X, and Y pathways, and a comparable set of koniocellular (K), parvocellular (P), and magnocellular (M) pathways exists in the monkey (see Chap. 6 for a fuller account of these and other retinal ganglion cell classes; see also Sherman and Spear, 1982; Rodieck and Brening, 1983; Stone, 1983; Shapley and Lennie, 1985; Sherman, 1985). There is evidence that the somatosensory first order relay is also involved in analogous parallel processing in the sense that each submodality or receptor type is represented by parallel neuronal streams through thalamus (Dykes, 1983). The important point is that in each relay, these parallel pathways show little or no interaction with each other. This may represent an important aspect of thalamic function generally. That is, functionally distinct driver pathways, even where they are intimately intermingled in a thalamic nucleus or a subdivision of a thalamic nucleus, may show no sign of integrative interactions. Although we have little relevant evidence for other thalamic relays, the shared common organizational plan seen throughout the thalamus suggests that this may prove to be a general rule. Certainly, as a general proposition about the thalamus, the hypothesis that there are no significant interactions between driver afferents in the thalamus bears serious consideration and experimental study.

#### MAPS IN THE THALAMUS

It is well established that the drivers concerned with visual, somatosensory, and auditory afferents are mapped. That is, within each of these first order relays, the relevant sensory surface is mapped. Correspondingly, the thalamocortical outputs from these relays are also mapped, so that for the visual pathways one can recognize a map of the retina (or of the visual field) in the lateral geniculate nucleus and also in the visual cortex that receives the geniculate input. The fact that there are maps in the thalamus looks

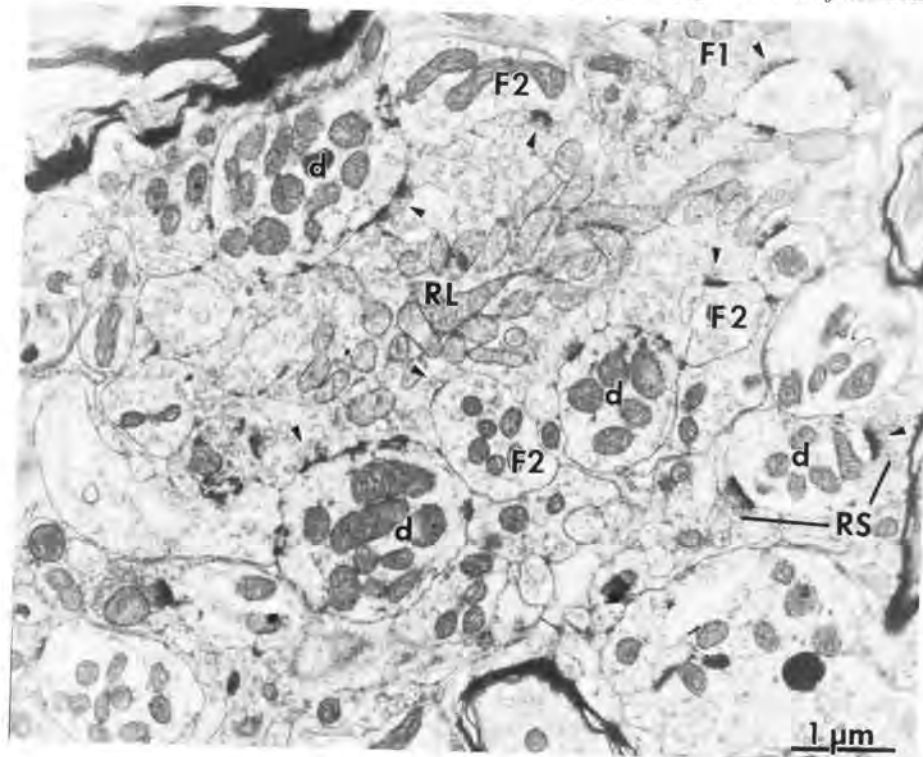

Fig. 8.2. Electron micrograph of a glomerulus from the A layers of the lateral geniculate nucleus of a cat with a centrally located RL terminal. Some of the synaptic junctions are identified by arrowheads. The major types of axon terminal are present and labeled F1, F2, RL, and RS (see text); "d" identifies some of the dendritic profiles (see Fig. 8.3). [From Sherman and Guillery, 2001.]

like another general principle that can be applied to all thalamic nuclei, because there is good evidence for an orderly pattern of organization between the thalamus and the cortex for most thalamic nuclei (Cowan and Powell, 1954; Frost and Caviness, 1980). However, for many of the thalamic nuclei we have no clear idea of what functional feature is mapped. This may prove to be an important point for future studies. For example, in the higher order relays concerned with vision (the pulvinar region), it is possible to define maps of the visual field, but they are less precise than the maps in the lateral geniculate nucleus, and as the connections are traced further beyond the first order geniculocortical relay, so the maps become less well defined. It is likely that the thalamocortical connections may then be concerned with mapping some other functional features, but at the present we have no evidence about the nature of these features.

### NEURONAL ELEMENTS OF THE THALAMUS

The neuronal elements of the thalamus can be divided into three components: the extrinsic afferent inputs to the relay nuclei, the relay cells (or principal neurons) that proj-

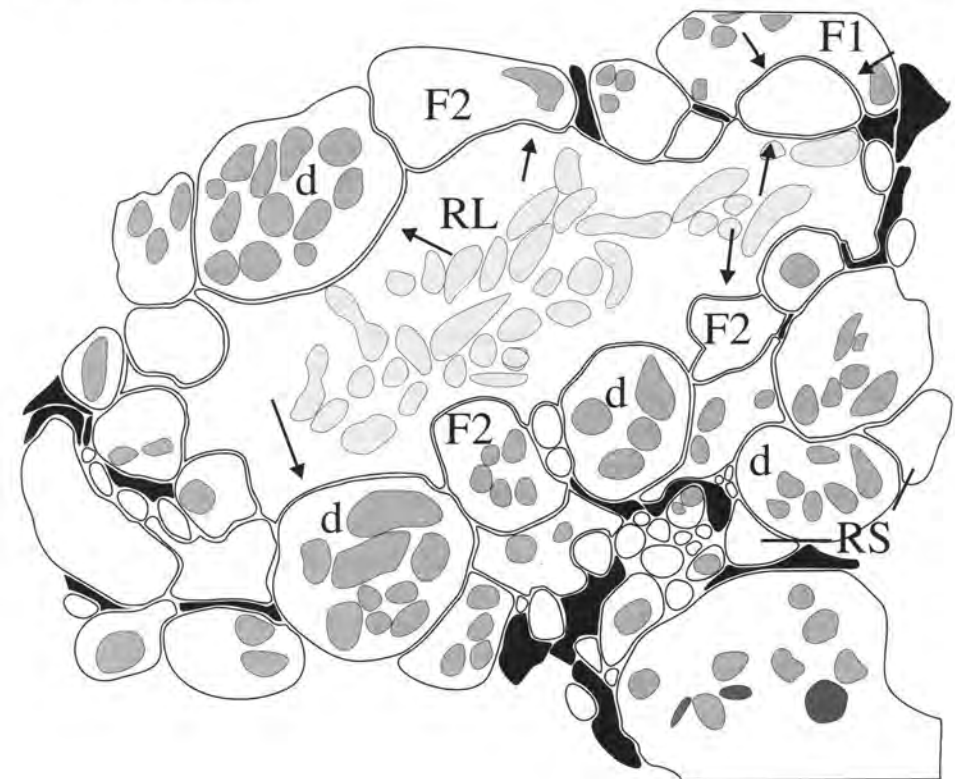

Fig. 8.3. Schematic interpretation of the major profiles shown in Fig. 8.2. [From Sherman and Guillery, 2001.]

ect to cortex (or other parts of the telencephalon; see earlier), and the interneurons (or intrinsic neurons). These structures have all been identified with light microscopic studies, and their synaptic relationships have been defined on the basis of electron microscopic studies that have over many years been closely related to studies involving the selective degeneration or labeling of specific axonal groups. Details can be found for a number of thalamic relays: the lateral geniculate nucleus (Guillery, 1969a,b; Wilson et al., 1984; Hamos et al., 1985; Jones, 1985; Montero, 1987), the ventral posterior nucleus (Jones and Powell, 1969; Ralston, 1969), the medial geniculate nucleus (Jones and Rockel, 1971; Morest, 1975), the ventral lateral nucleus (Harding, 1973; Ilinsky and Kultas-Ilinsky, 1990), the pulvinar region (Feig and Harting, 1998; Patel et al., 1999; Carden and Bickford, 2002; Wang et al., 2002a), and the anterior thalamic nuclei (Somogyi et al., 1978).

### THE ELECTRON MICROSCOPIC APPEARANCE OF THE NEURONAL ELEMENTS

Figures 8.2 and 8.3 show the profiles that can be seen in an electron microscopic section through the lateral geniculate nucleus of the cat. The organization that is seen here is characteristic of most of the thalamic nuclei of most species. Because most of the

thalamic nuclei of the rat and mouse contain very few or no interneurons (see also Interneurons), the thalamus of these species is unusual and the relationships between the profiles are somewhat simpler but apart from that one can expect to see the same structures anywhere in the thalamus. Identifying these structures and understanding their synaptic relationships are important for the sections that follow, because these represent the fundamental connectational patterns upon which our understanding of thalamic function must be based.

Four major types of synaptic terminal are present (Guillery, 1969a), and their origins have been defined by electron microscopic studies of degenerating or labeled thalamic neuronal elements. Examples can all be found in Fig. 8.2. *RL* terminals (round vesicles and large profiles) contribute 5%–10% of all synaptic contacts (Van Horn et al., 2001). These terminals form asymmetrical synapses, with more thickening of the postsynaptic membrane than the presynaptic one. Whereas asymmetrical synapses are a feature of most excitatory synapses in the mammalian brain, symmetrical synapses, which have roughly equal presynaptic and postsynaptic membrane thickenings, typify most inhibitory synapses. The *RL* terminals come from the retina and are glutamatergic. *RL* terminals with the same structure and relationships are also the driver terminals in other thalamic relays. *RS* terminals (round vesicles and small profiles) also form asymmetrical synapses and make up roughly half of all synapses present. In the lateral geniculate nucleus of the cat, there is no overlap in size between *RL* and *RS* terminals (Van Horn et al., 2000). Roughly half of the *RS* terminals are corticothalamic and they are glutamatergic; the remainder come from the brainstem. Most of the latter are cholinergic, although some are noradrenergic or serotonergic. *F* terminals (flattened vesicles) form symmetrical synapses and make roughly one quarter of the synaptic contacts; these are GABAergic. Two subtypes, *F1* and *F2*, have been recognized. Although a constellation of features can distinguish them, the most salient are that *F1* terminals are axonal and are strictly presynaptic, whereas *F2* terminals are dendritic in origin and are both presynaptic and postsynaptic. *F1* terminals arise from axons of reticular cells, interneurons, and, in the lateral geniculate nucleus, axons of cells of the nucleus of the optic tract; *F2* terminals are the dendritic processes of interneurons.

An overview (Erişir et al., 1997b; Van Horn et al., 2000) shows that the *RL* terminals form only 5%–10% of the synaptic profiles onto relay cells in the lateral geniculate nucleus, which is often seen as a surprisingly low number for driver inputs; for the remaining modulatory synaptic inputs to relay cells, roughly one-third come from local GABAergic sources (*F1* and *F2* terminals), one-third come from layer 6 of cortex (*RS* terminals), and one-third come from brainstem (*RS* terminals).

Dendrites of relay cells are postsynaptic to all of these terminals, and dendrites of interneurons are postsynaptic to all of these terminals except for *F2* terminals. The *F2* terminals are postsynaptic to *RL* terminals or *RS* terminals from brainstem; *F1* terminals are also occasionally presynaptic to *F2* terminals. The glomeruli, illustrated in Figs. 8.2 and 8.3 and described in more detail later, contain *RL* (driver) terminals, *F* terminals (both *F1* and *F2*), and *RS* terminals from brainstem. Cortical *RS* terminals rarely, if ever, innervate glomeruli.

One feature seen in Figs. 8.2 and 8.3, which is rare in most parts of the brain but is commonly seen where many thalamic synapses are closely interrelated, is that there is

little or no astrocytic cytoplasm between the synaptic profiles. Such regions have been called *glomeruli*. A glomerulus is a complex synaptic structure (see also Fig. 8.4), where interneuronal dendrites relate to driver terminals, relay cell dendrites, and other processes. As shown in Figs. 8.2, 8.3, and 8.4, the astrocytic processes tend to form around the glomeruli; their absence from among the synapses in the glomeruli suggests that here the functional relationships between synapses and astrocytes, which commonly involve transport of potassium ions and transmitter uptake mechanisms, are weak or absent. A comparable situation in the cerebellar glomeruli, which also lack astrocytic cytoplasm, has been studied in greater detail than have the thalamic glomeruli (see DiGregorio et al., 2002). The rat's ventral posterior lateral nucleus, which lacks interneurons (see Interneurons, earlier), also lacks glomeruli (Ralston, 1983), demonstrating that the typical glomerular structure depends on interneurons.

The retinal or driver terminal usually contacts several *F2* terminals within a glomerulus, and these interneuronal *F2* terminals in turn are presynaptic at symmetrical contacts to the *same* relay cell dendritic appendage or shaft that is contacted by the retinal terminal. Because three terminal types are involved, this special neuronal circuit within the glomerulus is known as a *triad* (for a detailed hypothesis concerning the role of

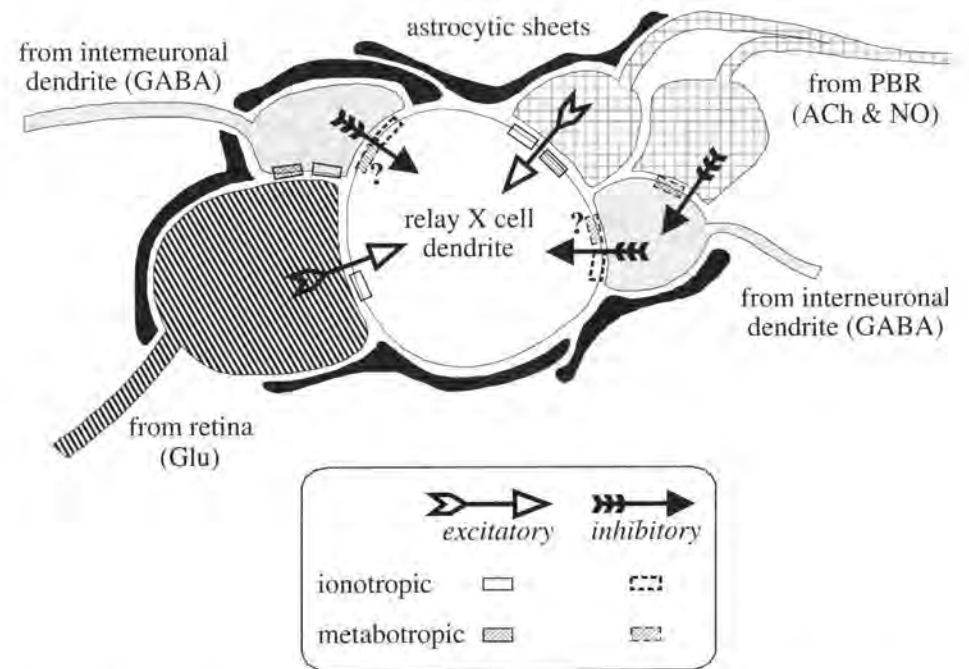

Fig. 8.4. Schematic view of a small glomerulus showing synaptic triadic arrangements. Arrows indicate direction of synaptic function, pointing from presynaptic to postsynaptic elements. The question marks postsynaptic to the dendritic terminals of interneurons indicate that it is not clear whether metabotropic ( $GABA_B$ ) receptors exist there. Abbreviation: PBR, parabrachial region.

these triadic circuits, see Koch, 1985); because the extrinsic input to this complex is retinal, this is called a *retinal triad*. A triad involving RL and F2 terminals and a dendritic appendage of a relay X cell is shown (see Fig. 8.8). A slightly different form of triad is the *parabrachial triad*. This involves two terminals from one parabrachial axon: one of the parabrachial terminals contacts an interneuronal dendritic terminal, and the other contacts a relay cell dendrite, with the dendritic terminal contacting the same relay cell dendrite (see Figs. 8.2 to 8.4).

#### INPUTS

Figure 8.5 schematically illustrates the major afferents for a typical dorsal thalamic nucleus. As indicated earlier, we can divide the inputs into two broad classes: driving and modulatory. The driving input represents the primary information to be relayed to cortex, such as retinal input to the lateral geniculate nucleus or cortical layer 5 input to a higher order relay. All of the other inputs are modulatory, and these serve to modulate or control the relay of information from the driving input to cortex. Modulatory inputs come from several different sources. Local inhibitory inputs come from interneurons and from cells in the thalamic reticular nucleus. Other modulatory inputs also come from layer 6 of cortex and from the brainstem. In addition to these, some other, potentially modulatory, inputs to some particular thalamic relays also exist, such as inputs from the tuberomammillary nucleus of the hypothalamus to the lateral geniculate nucleus and pulvinar region (Manning et al., 1996), from the pretectum to the lateral

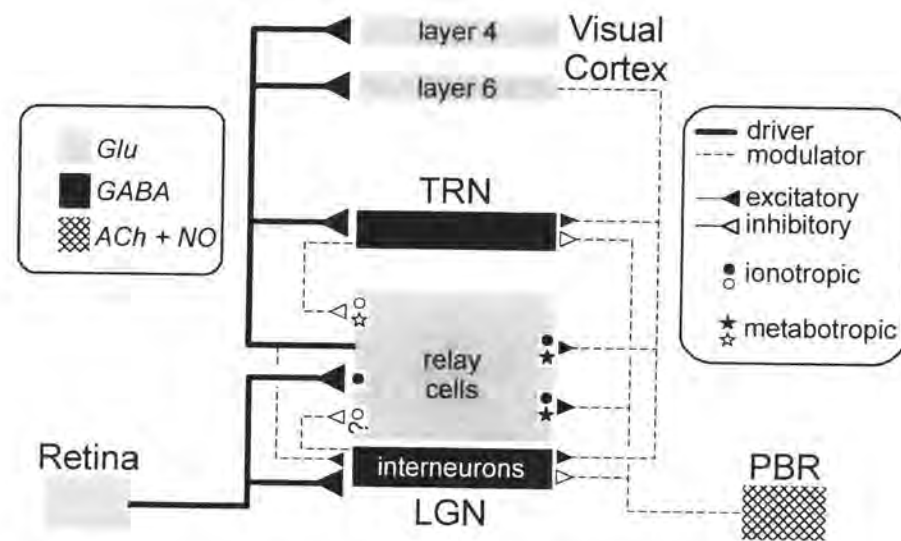

Fig. 8.5. Schematic view of details of the main connections of the lateral geniculate nucleus. Indicated are the inhibitory or excitatory nature of the synapses, the postsynaptic receptors activated by each input on relay cells, and the neurotransmitters involved. Abbreviations: LGN, lateral geniculate nucleus; PBR, parabrachial region; TRN, thalamic reticular nucleus.

geniculate nucleus (Cucchiari et al., 1991a), and from the basal ganglia to the ventral anterior nucleus (Ilinsky et al., 1997). Seen in this perspective, driving afferents to relay cells are one class among several and, in terms of number of synapses formed on relay cells, are a minority input (Guillery, 1969a,b; Liu et al., 1995; Van Horn et al., 2000).

**Driving Afferents.** The driving input from the retina to the lateral geniculate nucleus is the best characterized input to a dorsal thalamic nucleus. This input comes from the ganglion cells of the retina, whose axons travel in the *optic nerve* and *tract* to the lateral geniculate nucleus and also go to the superior colliculus, pretectum, and ventral lateral geniculate nucleus. The geniculate input is glutamatergic (Salt, 1988; Scharfman et al., 1990; Kwon et al., 1991). Comparable driving inputs to the ventral posterior and medial geniculate nuclei come from the *medial lemniscus* and inferior colliculus, respectively. We have seen that these afferents have a characteristic fine structural appearance and synaptic organization. Light microscopically, they are also readily identifiable, regardless of whether they are ascending afferents to a first order relay or axons from cortical layer 5 going to a higher order nucleus. The structural distinction between the drivers and the corticothalamic modulators that come from layer 6 is always clear in all thalamic nuclei, and this is illustrated in Fig. 8.6.

**Cortical Afferents.** There are a great many corticothalamic afferents that arise from pyramidal cells in layer 6 of all cortical areas, and all thalamic nuclei receive such axons. For the visual pathways, there is at least an order of magnitude more corticothalamic axons than thalamocortical ones (Sherman and Koch, 1986). For the lateral geniculate nucleus and for all of the first order relays, all of the cortical afferents come from layer 6. Cortical afferents to higher order relays from layer 5 are considered separately. Each cortical axon innervates many thalamic neurons, thereby establishing considerable divergence and convergence in the corticothalamic pathway. Like retinal (or other driving) axons, these cortical axons from layer 6 are excitatory and appear to be glutamatergic (Giuffrida and Rustioni, 1988; McCormick and Von Krosigk, 1992; Montero, 1994). Strong reciprocity exists in thalamocortical connections, because the cortical input for each thalamic nucleus generally, but not always, originates from the same cortical area that is innervated by the thalamic nucleus in question. Thus, for the lateral geniculate nucleus, this cortical pathway comes from visual cortex (mostly areas 17, 18, and 19), and likewise, somatosensory and auditory cortex project back, respectively, to the ventral posterior lateral and medial geniculate nuclei.

One implication of this reciprocity is that the corticothalamic pathway faithfully adheres to the map established in the thalamic nucleus. For instance, the corticogeniculate pathway conforms to the retinotopic map in the lateral geniculate nucleus. However, there is some question as to the extent to which the maps match at the cellular level. This is based on evidence that, in the cat (Murphy and Sillito, 1996), the spread of an individual corticogeniculate axon arbor can be quite extensive, reaching well beyond the region within which receptive fields that match those of the cortical axon can be recorded. The corticogeniculate terminals have a maximal extent of 1.5 mm compared with the spread of a typical retinogeniculate arbor of only about 0.2–0.4 mm (Bowling and Michael, 1984; Sur et al., 1987). The retinogeniculate arbor's expanse roughly

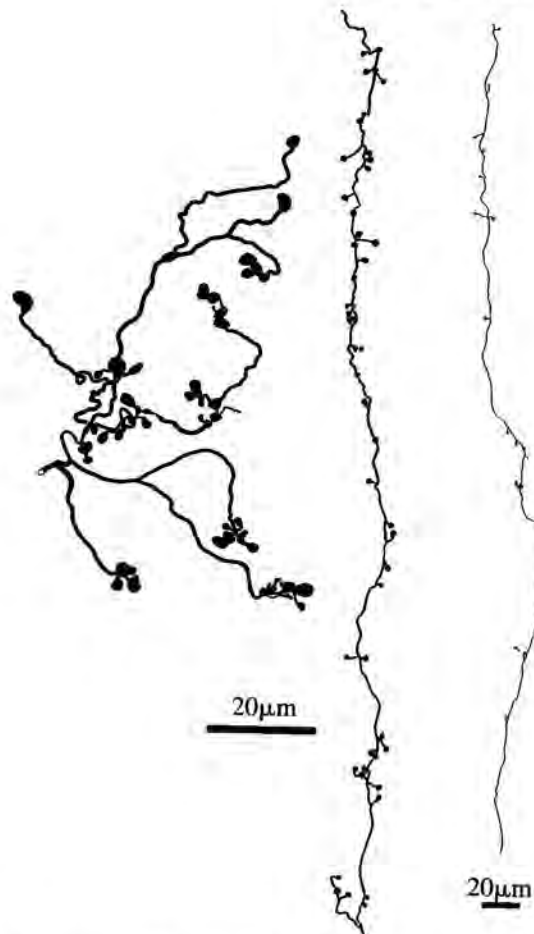

Fig. 8.6. Tracings of partial terminal arbors of three corticothalamic axons in the pulvinar region labeled by biotinylated dextran amine. The axon on the left, a type 2 axon (Guillery, 1966), displays driver morphology from cortical layer 5, and the two on the right, type 1 axons (Guillery, 1966), display modulator morphology from layer 6. [From Sherman and Guillery, 2001.]

corresponds to the size of a geniculate receptive field, implying that the corticogeniculate axonal arbor can contribute to subtle effects on relay responses beyond the "classic" receptive field. However, the majority of the corticothalamic terminals lie in a central core that roughly corresponds to the classical receptive field.

In visual cortex, only a subset of pyramidal cells in layer 6 actually sends axons into the corticothalamic pathway, with the remainder either innervating the claustrum or not projecting out of cortex, and the corticothalamic cells tend to be located in the top half of layer 6 (Lund et al., 1975; Katz, 1987; Usrey and Fitzpatrick, 1996). These layer 6 corticothalamic cells also project into that part of layer 4 that is supplied by geniculocortical input (Lund et al., 1975), implying that these layer 6 cells not only modulate the relay of information through the lateral geniculate nucleus but may also modulate

the flow of geniculate input into cortex. This layer 6 projection to layer 4, unlike some other intrinsic cortical circuits, is very limited in horizontal extent (Katz, 1987), thereby limiting the retinotopic spread of effect.

Finally, corticothalamic neurons are heterogeneous and probably represent several functional classes identifiable on the basis of axonal conduction velocities and receptive field properties (Tsumoto and Suda, 1980) or on the basis of their dendritic and intracortical axonal arbors (Katz, 1987). For somatosensory cortex of the rat, Zhang and Deschênes (1997) have distinguished corticothalamic cells that project to a first order nucleus (ventral posterior) from those that project to a higher order relay (the posterior group). They differ in their intracortical axonal and dendritic arbors; the former lie in the more superficial parts of layer 6, and the latter, in the deeper parts. It is not clear exactly how the several different cell types relate to the relay functions of the thalamus, but it is important to stress that the variety of these cortical cells suggests a corresponding variety of modulatory functions in the thalamus that are still largely unexplored.

**Inputs From the Thalamic Reticular Nucleus.** Other inputs to each dorsal thalamic nucleus come from the thalamic reticular nucleus (Ohara and Lieberman, 1985; Jones, 1985; Cox et al., 1996; Sherman and Guillery, 2001). This nucleus forms a thin shell of cells lateral to the dorsal thalamus (lying in the path of the thalamocortical and corticothalamic axons; see Fig. 8.1). Generally, functionally related groups of dorsal thalamic nuclei (e.g., visual, auditory, somatosensory) form reciprocal connections with a sector of the reticular nucleus (Jones, 1985; Sherman and Guillery, 1996, 2001; Guillery et al., 1998). That is, relay cell axons on their way to cortex pass through the appropriate reticular sector and give off branches with terminals in that sector, and the reticular cells in turn send axons back into the same part of the dorsal thalamic nucleus. It is worth noting that the functionally related corticothalamic axons from layer 6 also pass through the appropriate reticular sector as they go to their thalamic destination, and these axons also provide collateral innervation to these reticular cells. The cortical and thalamic inputs to the reticular nucleus are mapped (Crabtree and Killackey, 1989; Crabtree, 1996, 1998; Conley and Diamond, 1990; Conley et al., 1991), and this relatively accurate mapping stands in sharp contrast to earlier views of the reticular nucleus as diffusely organized. Finally, the thalamic reticular nucleus is also innervated by the same regions of brainstem that innervate the dorsal thalamus. The reticular cells are GABAergic and inhibit their dorsal thalamic targets, which are nearly exclusively relay cells rather than interneurons (Cucchiaro et al., 1991b; Wang et al., 2001).

**Brainstem Afferents.** A final extrinsic source of innervation to the thalamus comes from various brainstem sources. The mix and relative strength of these brainstem inputs can vary both with species as well as with specific thalamic nuclei (Fitzpatrick et al., 1989). Afferents from the pons and midbrain (see Fig. 8.5) include cholinergic neurons (i.e., using acetylcholine as a neurotransmitter) of the *parabrachial region* (the cells of origin are located near the brachium conjunctivum; this is also known as the *pedunculo-pontine tegmental nucleus*), noradrenergic neurons (i.e., using noradrenaline, also known as norepinephrine) of the *locus coeruleus* and parabrachial region (i.e., most cells there are cholinergic, but some are noradrenergic), and serotonergic neurons of

the dorsal raphe nucleus. These inputs can either excite or inhibit thalamic neurons (see Chapter 2 and below). By far the most numerous of these inputs to the lateral geniculate nucleus is the cholinergic input, representing perhaps 90% of the brainstem input in the cat (Smith et al., 1988; Bickford et al., 1993) and 100% in the monkey (Bickford et al., 2000). However, there may be considerable variability in the relative distribution of these various brainstem inputs to different thalamic nuclei (Fitzpatrick et al., 1989).

Figure 8.3 shows the main inputs to thalamus, but other modulatory inputs that vary across nuclei also exist, and these have been most closely studied for the lateral geniculate nucleus (Harting et al., 1986; Fitzpatrick et al., 1988a; Cucchiari et al., 1991a, 1993; Uhlrich et al., 1993; Bickford et al., 1994). The tuberomammillary nucleus of the hypothalamus provides a histaminergic input. A GABAergic input exists from the basal forebrain to the thalamic reticular nucleus, and while this input does not directly innervate dorsal thalamus, it can influence relay properties indirectly via reticular inputs to relay cells described in the previous section. Finally, the lateral geniculate nucleus receives additional, although sparse, brainstem inputs that may be unique to the visual pathways, and these are also omitted from Fig. 8.5. These include afferents from the superior colliculus and parabigeminal nucleus of the midbrain and from the pretectal nucleus of the optic tract. The parabigeminal input is cholinergic, that from the pretectum is GABAergic, and that from the superior colliculus is thought to be glutamatergic. There is evidence that the GABAergic input from the nucleus of the optic tract does not innervate relay cells directly but instead innervates reticular cells and interneurons, which would presumably disinhibit relay cells (Cucchiari et al., 1993; Wang et al., 2002b).

Although modulatory inputs other than those shown in Fig. 8.3 have not been much explored in other thalamic relays, one that is particularly interesting to consider is that from the basal ganglia to the ventral anterior and lateral nuclei. This is a GABAergic, inhibitory pathway, and it is notable, because in many textbooks (e.g., Purves et al., 1997; Kandel et al., 2000) this pathway is treated as though it were a driver, functionally comparable to the retinal, lemniscal, or cerebellar inputs, which are either known drivers or have the morphological characteristics of a driver and use the same transmitter. However, there is reason to believe that inhibitory inputs are unlikely to be drivers (Smith and Sherman, 2002). This is because inhibitory inputs are effective only when they cancel postsynaptic spikes, whereas excitatory inputs work by adding spikes; spike cancellation can occur only within a limited temporal window during which a spike and inhibitory input coincide, whereas excitatory inputs can add spikes during virtually any period in the postsynaptic spike train as long as the background firing rates are not near saturation levels. At physiological rates of spontaneous activity (say,  $\leq 30$ – $50$  spikes/sec), excitatory inputs are far more effective in altering the spike train than are inhibitory ones (Smith and Sherman, 2002). Thus we suspect that this is a modulatory input. Driver inputs to these nuclei appear to come from cerebellum and from cortical layer 5 (see also Chap. 9).

#### RELAY NEURONS

Relay neurons are the only output of a dorsal thalamic nucleus. Their axons go predominantly to the neocortex, with some (from the intralaminar nuclei) going to the

striatum and others also going to the amygdaloid complex. Many, possibly all, of these axons send a branch to the thalamic reticular nucleus (see Fig. 8.1).

**Classes of Relay Cell.** We have indicated (see Parallel Processing) that there are three parallel pathways connecting the retina through the lateral geniculate nucleus to the visual cortex. Two of them connect through the A layers of the cat's lateral geniculate nucleus. Figure 8.7A,B shows examples of these relay cells and shows that they are morphologically distinct: Y cells have cruciate arbors that radiate symmetrically from the soma and are mostly devoid of complex appendages; X cells tend to be elongated along projection lines and usually have complex appendages near primary branch points. These appendages mark the postsynaptic location of retinal inputs involved in the glomeruli and triads, in accordance with the observation that X cells participate in triads, whereas Y cells do not (Wilson et al., 1984; Hamos et al., 1987; but see

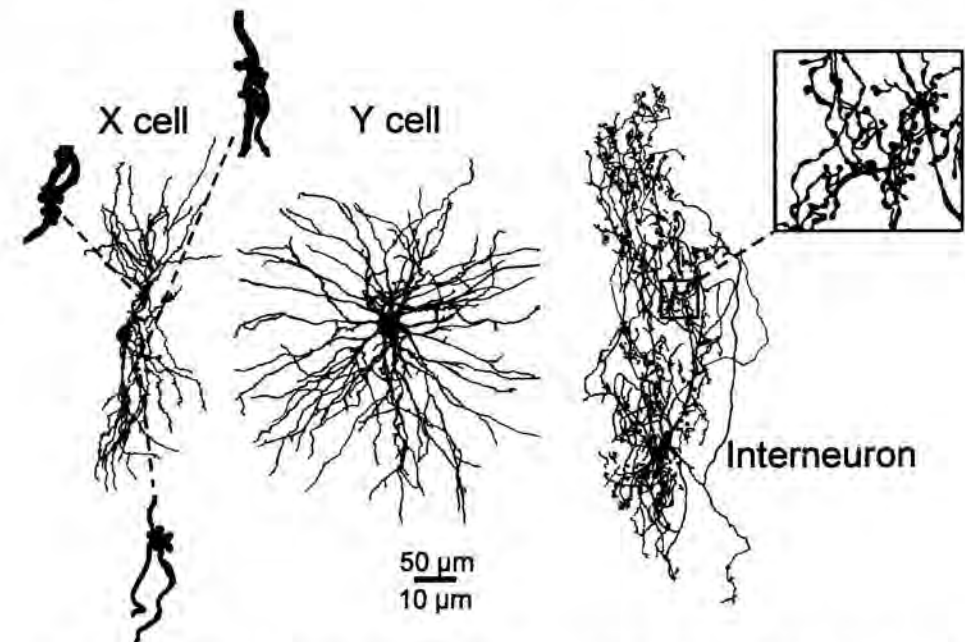

Fig. 8.7. Tracings of a relay X and Y cell and interneuron from the A layers of the cat's lateral geniculate nucleus. These were all physiologically identified during *in vivo* recording and filled intracellularly with horseradish peroxidase for morphological analysis (Friedlander et al., 1981; Hamos et al., 1985). The dendritic arbor of the X cell is tufted and elongated, oriented perpendicular to the plane of the layers, whereas the Y cell dendrites show a stellate distribution with an approximately spherical arbor. The X cell also has prominent clusters of dendritic appendages near proximal branch points. These are hard to see in the cell reconstructions, so three examples are shown at greater magnification, with dashed lines indicating their dendritic locations (the scale is  $50 \mu\text{m}$  for the cell reconstructions and  $10 \mu\text{m}$  for the dendritic appendage examples). The interneuron is also elongated in a direction perpendicular to the layers and has richly branched, thin dendrites with an axoniform appearance. The upper inset shows an enlarged view of the dendritic terminals (the scale, again, is  $10 \mu\text{m}$  for this). [Redrawn from Sherman and Guillery, 2001.]



Datskovskaia et al., 2001; Dankowski and Bickford, 2003). Comparable morphological distinctions between two types of relay cell have been described in several other thalamic nuclei (Kölliker, 1896; Morest, 1964; Pearson and Haines, 1980; Bartlett et al., 2000). Although the functional properties of the pathways through these relays are not as clear as they are in the lateral geniculate nucleus, it is important to stress that most thalamic nuclei have RL terminals related to triads in glomeruli as well as RL terminals that relate more simply to dendritic stems. That is, pathways comparable to the X and Y pathways of the cat's lateral geniculate nucleus are to be expected in all thalamic nuclei that have significant numbers of interneurons. The cortical axon terminals of the geniculate relay cells distribute primarily to layer 4 of the cortical target area, with a smaller terminal zone in layer 6 and some in more superficial layers.

**Calcium Binding Proteins.** A different classification of relay cells has been proposed by Jones (1998). This is based on two different calcium binding proteins that characterize the relay cells. Larger cells that generally dominate in first order nuclei are immunoreactive for parvalbumin. Smaller cells are immunoreactive for calbindin, and these are more densely distributed in parts of the thalamus other than the first order nuclei. Jones describes the parvalbumin-positive cells as forming a core of thalamic cells and the calbindin-positive cells as forming a matrix. The core cells project to layers 3 and 4 of cortex and carry well-mapped projections to cortex. Matrix cells are more likely to project to layer 1 of cortex, and their axons are more widely (diffusely) distributed to the cortex. That is, Jones regards the core as concerned with sending specific, well localized messages, whereas the matrix conveys more diffuse messages to cortex concerned with controlling the rhythmic discharges of cortical cells that have been proposed as playing a role in perceptual binding (Singer and Gray, 1995; Singer, 1999). This categorization applies primarily to the monkey thalamus; the calcium binding proteins do not show the same patterns in other mammals (Ichida et al., 2000).

It should be stressed that although matrix cells are more common in parts of the thalamus that contain higher order relays, the higher order relays from, for example, the pulvinar region connect to layer 3 of cortex and should not be thought of as contributing to a diffuse system. The first order/higher order distinction described here does not correspond to the core/matrix distinction proposed by Jones.

From the point of view of the lateral geniculate nucleus itself, the parvalbumin/calbindin distinction as representative of a functional core/matrix difference is somewhat problematical. The koniocellular system in the monkey is calbindin positive, whereas the parvocellular and magnocellular layers are parvalbumin positive. The koniocellular layers project to layer 3, and there is no evidence that would suggest that they represent a diffuse system.

#### INTERNEURONS

Roughly 20%–25% of the cells in most thalamic nuclei of most species are local interneurons (Arcelli et al., 1997). The figure is comparable for the lateral geniculate nucleus of the rat and mouse. Oddly, other thalamic nuclei in the rat and mouse, but not in other rodents, have practically no interneurons (Arcelli et al., 1997). Thus analogous nuclei in the same animal (e.g., the rat's lateral geniculate and ventral posterior lateral

nuclei) can vary in this regard, as can homologous nuclei across species (e.g., the ventral lateral posterior nuclei of cats and rats).

The most intensively studied interneurons are those found in the A layers of the cat's lateral geniculate nucleus (see Fig. 8.7), but they are basically similar in other thalamic nuclei (Guillery, 1966, 1969a,b; Ralston, 1971; Morest, 1971; Hamos et al., 1985; Carden and Bickford, 2002). These geniculate interneurons have small cell bodies with long, thin, and sinuous dendrites (Fig. 8.7C). The dendrites are notable for giving rise to bulbous appendages connected to the stem dendrite by long ( $\geq 10 \mu\text{m}$ ), thin (usually  $< 0.1 \mu\text{m}$  in diameter) processes; these appendages usually occur in clusters. Overall, the dendrites with their bulbous appendages look like the terminal arbors of axons, and thus Guillery (1966) referred to these dendrites as "axoniform" in appearance. In fact, these bulbous appendages represent the F2 terminals described earlier, which are both presynaptic and postsynaptic to other elements in the lateral geniculate nucleus (Guillery, 1969a,b; Morest, 1971; Ralston, 1971; Famiglietti and Peters, 1972; Hamos et al., 1985; Ralston, et al., 1988). Most of the synapses from interneurons are thus dendritic in origin.

These interneurons usually have a conventional axon that arborizes locally, typically within the dendritic arbor (Hamos et al., 1985; Montero, 1987), although axonless interneurons may exist (Ralston et al., 1988). Inputs to these interneurons in the lateral geniculate nucleus include many from retina, exclusively or nearly so from X axons (Sherman and Friedlander, 1988). Their dendritic outputs contact mostly only relay X cells in triadic arrangements within glomeruli associated with proximal dendrites of the target cell (Hamos et al., 1985, 1987; but see Datskovskaia et al., 2001; Dankowski and Bickford, 2003). Evidence for interneuronal influences on relay Y cells also exists (Lindström, 1982), and this probably reflects the axonal output. All interneurons are GABAergic, and both their dendritic and axonal outputs inhibit their postsynaptic targets.

There is clear evidence that other types of interneuron exist. The interneurons described in the preceding paragraphs lack the enzyme brain nitric oxide synthase (BNOS), but other interneurons do contain BNOS and they are morphologically distinguishable (Meng et al., 1996; Carden and Bickford, 2002). In the cat's pulvinar region and in the C layers of the cat's lateral geniculate nucleus, the interneurons with BNOS have larger cell bodies and dendrites that radiate in all directions over a larger distance than do those of the other interneurons (Bickford et al., 1999; Carden and Bickford, 2002). Also, these latter interneurons have different input/output characteristics than do those without BNOS (Carden and Bickford, 2002): they receive no inputs from terminals with driver morphology, and although both make dendrodendritic contacts (and, indeed, those with BNOS have no detectable axon), they contact relay cells on distal dendrites, outside glomeruli).

A potentially different type of interneuron is one found in the interlaminar zones of the ferret's lateral geniculate nucleus (Sanchez-Vives et al., 1996). These have been described as a displaced part of the thalamic reticular nucleus, in part because they lack a direct driver (retinal) innervation. This is similar to the interneurons with BNOS in the pulvinar region, but, unfortunately, there is as yet no description of their BNOS content.

Clearly, we need a more complete survey of the various types of interneuron found in thalamus and we need to define each type in terms of the details of its contribution to thalamic circuitry.

## CELLS OF THE THALAMIC RETICULAR NUCLEUS

As noted earlier, the thalamic reticular nucleus is a source of modulatory afferents to the dorsal thalamus. The axons of reticular cells do not go beyond the thalamus; instead they provide local, GABAergic, inhibitory input to thalamic relay cells. They are thus functionally similar in some ways to interneurons, and many investigators group them with interneurons as local inhibitory cells. However, two clear differences between interneurons and reticular cells are that only the former have dendritic appendages that are presynaptic to relay cells and that reticular cells receive no synaptic contacts from the driver afferents to thalamic relay cells.

## SYNAPTIC CONNECTIONS

## INPUTS TO RELAY CELLS

Reconstructions from electron micrographs show that thalamic relay cells receive roughly 4000–5000 synapses, nearly all onto their dendrites, with rare contacts on the cell bodies (Wilson et al., 1984; Liu et al., 1995). Figure 8.8 schematically summarizes the distribution of various types of synaptic input on the dendritic arbors of relay X and Y cells of the cat's lateral geniculate nucleus. Relay cells in other thalamic nuclei probably have a comparable pattern of synaptic inputs (Wilson et al., 1984; Liu et al.,

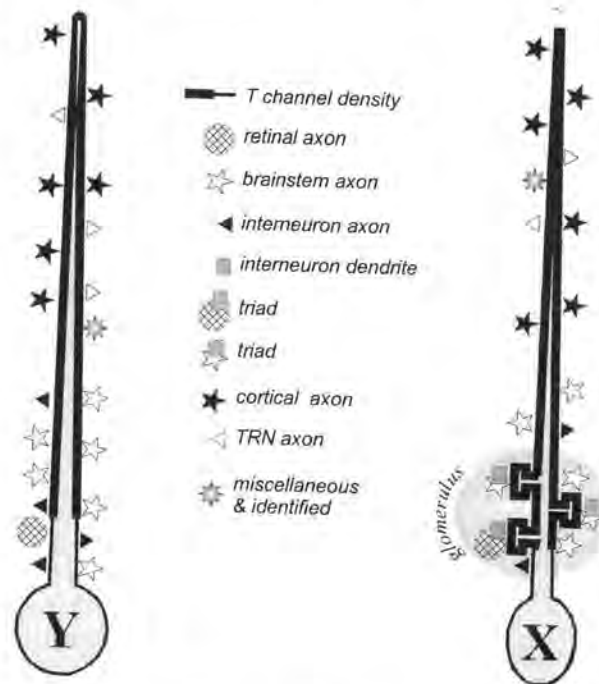

Fig. 8.8. Schematic view of synaptic inputs onto an X cell and a Y cell of the lateral geniculate nucleus of the cat. The T channels are also shown. They are found throughout the cell body and dendritic membranes but are denser on the dendrites than on the cell body. Note that retinal, interneuronal, and parabrachial inputs contact proximal dendrites, whereas cortical and reticular inputs are concentrated on peripheral dendrites. [Redrawn from Sherman and Guillery, 2001.]

1995). For both relay X and Y cells, inputs from retinal terminals concentrate in the proximal region of the dendritic arbor, whereas cortical RS input dominates distal dendrites, and there is little or no overlap of these zones. Parabrachial RS terminals are found proximally, among retinal terminals. F terminals are found all along the dendritic arbor but are more numerous proximally. Interestingly, among the F1 terminals, those from reticular cells are mostly located distally, among cortical RS terminals (Wang et al., 2001). The remaining F1 terminals are found proximally, and these, by a process of elimination, must derive mostly from axons of interneurons.

However, major differences between relay X and Y cells exist in the types of F terminal present and in the detailed nature of the retinal input. In particular, the innervation of X cells heavily involves triads and glomeruli, but that of Y cells does not. That is, the vast majority of retinal inputs to relay X cells are filtered through the complicated circuitry of the glomerulus. Retinal input to relay Y cells is simpler and involves conventional asymmetrical synapses onto proximal dendritic shafts (Wilson et al., 1984; Sherman, 1988). F2 terminals are nearly always limited to glomeruli, and the lack of glomeruli associated with the Y pathway results in very few such terminals contacting relay Y cells (but see Datskovaia et al., 2001; Dankowski and Bickford, 2003). More than 90% of the F input to these cells is of the F1 variety, whereas roughly two-thirds of F input onto relay X cells is of the F2 variety.

## INPUTS TO INTERNEURONS

As with our previous examples, most of our detailed knowledge of interneurons stems from studies of the lateral geniculate nucleus, but comparable studies in other thalamic nuclei, especially the ventral posterior lateral nucleus, reveal basically similar properties for thalamic interneurons (Ralston et al., 1988). In the lateral geniculate nucleus, many retinal, RS, and F1 terminals contact interneurons (Hamos et al., 1985). RS terminals include cortical (from layer 6) and parabrachial sources, as for relay cells, but relay cells themselves also innervate interneurons via local collaterals (Cox and Sherman, 2003), and it is likely that these terminals are also of the RS type. Much of this input is focused onto the dendritic appendages, which are the presynaptic F2 terminals. Input is also formed onto dendritic shafts and cell bodies, and these are the only geniculate neurons that seem to receive significant retinal input onto their cell bodies.

## BASIC NEURONAL CIRCUIT

Enough is known about the cat's lateral geniculate nucleus to provide a schematic circuit diagram, including a fair estimate of the numbers of neuronal elements present. Of course, many of the specific features of this diagram remain somewhat uncertain, but the broad outlines are clear. It is likely that these broad outlines apply as well to other thalamic nuclei.

## COMPONENT POPULATIONS

As noted earlier, roughly three-fourths of the neurons in the A-laminae are relay cells, and the rest are interneurons. The interneurons have two outputs, the major one being the dendritic F2 terminals and the minor one being the axonal F1 terminals (see Figs. 8.2, 8.3, and 8.4). The dendritic output of interneurons targets relay X cells nearly exclusively (but see Datskovaia et al., 2001; Dankowski and Bickford, 2003), and the

axons target both X and Y cells. Relay X cells somewhat outnumber relay Y cells (Sherman, 1985). These geniculate neurons are specifically innervated by appropriate retinogeniculate axons—X to X and Y to Y—but the details of how other axons (from cortex, brainstem, and local GABAergic sources) innervate relay X and Y cells or interneurons are not yet clear. We also still lack estimates for the number of afferent axons from the thalamic reticular nucleus and various brainstem sites, and such estimates are only in part available for other species.

#### INTRINSIC CIRCUITRY

The basic organization of major inputs to the cat's lateral geniculate nucleus is summarized schematically in Fig. 8.9. Many of the details of this circuit, including the differences between the X and Y pathways, were described earlier. These relay cells also receive input from cortex and from the brainstem. Major inhibitory input comes from local GABAergic cells, which are the interneurons and reticular cells. Both of these GABAergic cells are innervated by cortex and by the brainstem parabrachial region. In addition, interneurons and reticular cells are innervated by axon collaterals from the relay cells, and interneurons also receive input from retinal X axons. Reticular cells also receive a GABAergic input from the basal forebrain. Not included, for simplicity, are lesser known and probably smaller inputs described earlier from the hypothalamus

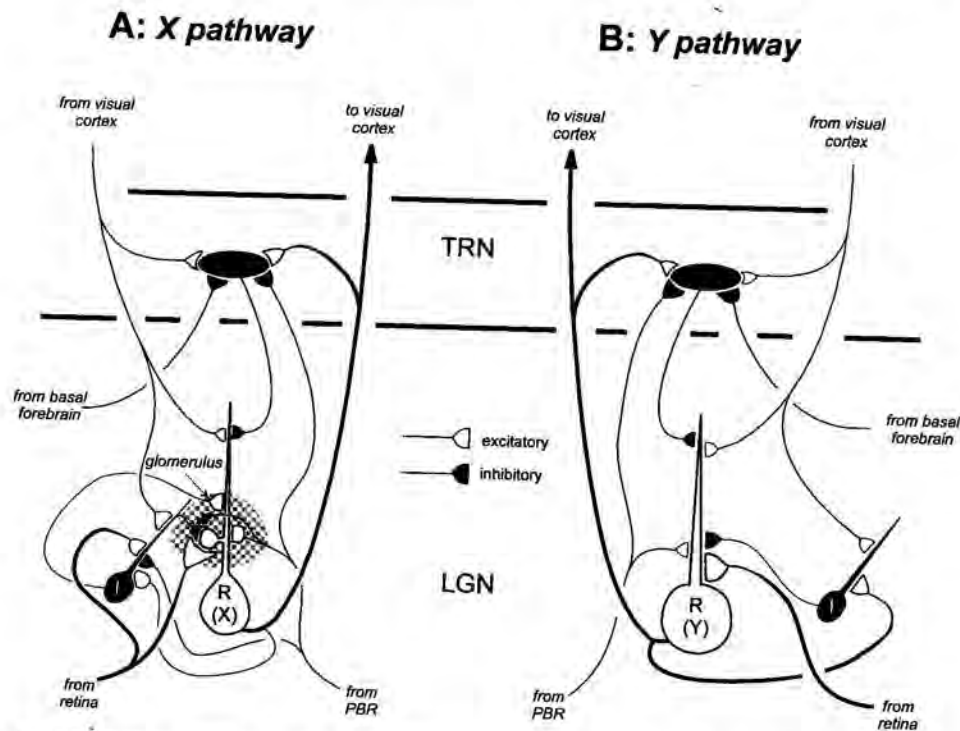

Fig. 8.9. Detailed circuitry related to X and Y relay cells of the lateral geniculate nucleus of the cat. Abbreviations: I, interneuron; LGN, lateral geniculate nucleus; PBR, parabrachial region; R, relay cell; TRN, thalamic reticular nucleus.

(histaminergic), pretectum (GABAergic), the parabrachial region or locus coeruleus (noradrenergic), and the dorsal raphe nucleus (serotonergic).

Although much of the circuitry outlined in Fig. 8.9 is sketchy, the following conclusions can be tentatively drawn. Much of this repeats earlier points, but it is offered here as a concise summary. Relay cells receive retinal input onto proximal dendrites in close association with some GABAergic and parabrachial input. The proximal GABAergic input, both axonal (F1) and dendritic (F2), derives from interneurons. Distal dendrites are dominated by cortical input, and, at least for geniculate relay cells, these inputs are limited to dendritic locations more distal than those of retinal inputs (Guillery, 1969a,b; Wilson et al., 1984; Erişir et al., 1997a). Some GABAergic inputs can also be seen on distal dendrites, and these derive from reticular cells. However, the electrotonic compactness of relay cells implies that even the distal inputs can be quite important functionally (see also Dendritic Cable Properties).

Figure 8.9 also summarizes some differences between the X and Y pathways, and perhaps this can be taken as a reflection of the kinds of variation present throughout thalamic circuitry. Three main differences exist: the nature of retinal input, the presence of glomeruli, and the role of interneurons. Retinal input to relay Y cells is fairly straightforward, innervating proximal dendritic shafts in simple contact zones. Retinal input to relay X cells is much more elaborate, because it involves complicated triadic relationships that include dendritic terminals of interneurons. Glomeruli are also a major feature of X, but not Y, circuitry, and the glomerulus may be viewed as a major filter of retinogeniculate transmission (see The Electron Microscopic Appearance of the Neuronal Elements). Finally, interneuronal dendritic outputs also seem to be intimately related to X, but not Y, circuitry. The axonal targets of interneurons appear to innervate both X and Y cells proximally, and those of reticular cells, distally.

It should be emphasized that the circuit schematically represented in Fig. 8.9 is preliminary and greatly simplified. Many questions still remain. For example, what is the interrelated pattern of innervation involving single cortical axons, reticular cells (or interneurons), and relay cells? The implication of this last question is illustrated in Fig. 8.10A,B showing two extremes of possible functional circuits involving inputs to relay cells and the local, GABAergic inhibitory cells. This reflects our superficial knowledge of interconnections among these cell populations and makes the point that in many cases we still cannot even determine if activation of these circuits excites or inhibits relay cells. For instance, Fig. 8.10A shows a true feedback inhibitory circuit in which an axon collateral from a relay cell (*cell b*) excites a reticular cell (*cell 2*) that in turn inhibits this same relay cell. In Fig. 8.10B, there is a very different relationship: now relay *cell b* excites reticular cells 1 and 3, but not cell 2, and reticular cells 1 and 3 do not inhibit relay *cell b* but rather inhibit its neighbors (*cells a* and *c*). Because *cells a* and *c* excite the reticular cell (*cell 2*) that inhibits relay *cell b*, the net result of the circuit depicted in Fig. 8.10B is that activity in relay *cell b* results in its further *disinhibition*, which is precisely the opposite of the feedback inhibition resulting from Fig. 8.10A. Likewise, the circuits shown in Fig. 8.10C,D have opposite effects when the corticogeniculate axon is activated: that in Fig. 8.10C results in feedforward inhibition of relay *cell b*, whereas that in Fig. 8.10D results in feedforward disinhibition of this same cell. The message here is that the details count, particularly for connections of

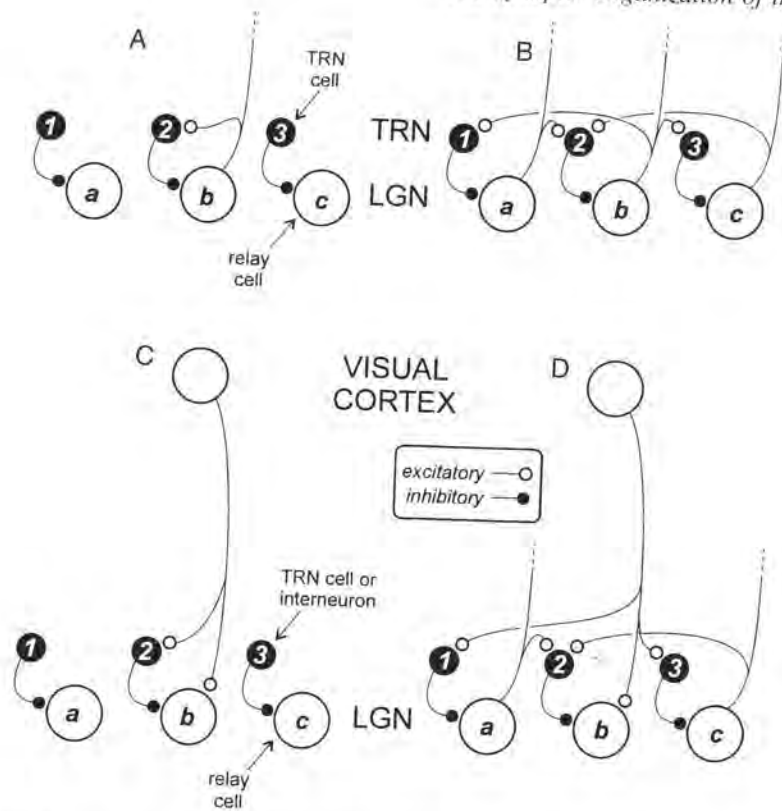

Fig. 8.10. Schematic view of different possible circuits involving the thalamic reticular nucleus that have quite different effects on relay cells. See text for details. [From Sherman and Guillery, 2001.]

individual neurons, and we are not yet sufficiently certain of many of the details to determine the final effect on relay cells of activating certain inputs or local circuits. It should be noted that the circuits depicted here are probably extreme examples, and combinations of each type may well exist.

### DENDRITIC CABLE PROPERTIES

#### RELAY CELLS

Both X and Y classes of relay cell are electrically rather compact, with dendritic arbors extending for roughly one length constant (Bloomfield et al., 1987; Bloomfield and Sherman, 1989). In practice, this means that even the most distally located synaptic input can have significant effects on the soma and axon, with attenuation of postsynaptic potentials never exceeding one-third to one-half (Fig. 8.11). One of the reasons for the electrotonically restricted dendritic arbors of relay X and Y cells is the nature

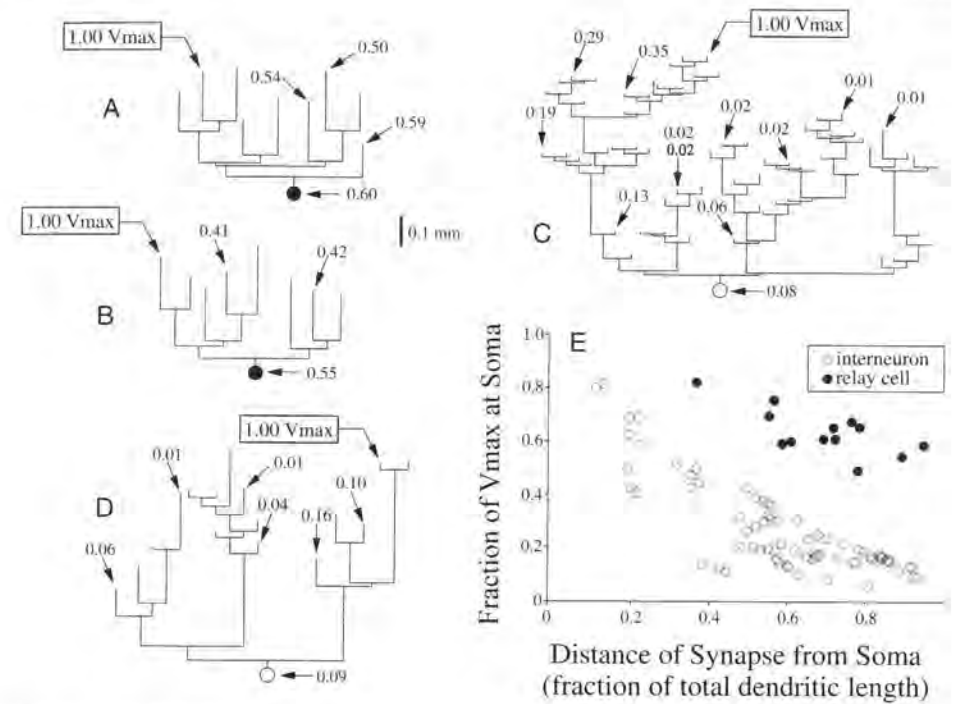

Fig. 8.11. A–D: Cable modeling of the voltage attenuation occurring within the dendritic arbors of two relay cells (A and B) and two interneurons (C and D) from the cat's lateral geniculate nucleus following a single voltage injection to mimic the activation of a single synapse. The cells were labeled by intracellular injection of horseradish peroxidase *in vivo*, and the stick figures schematically represent one primary dendrite from each cell with all of its progeny branches. Each branch length is proportional to its calculated electrotonic length. The site of voltage injection is indicated by the boxed value labeled 1.00  $V_{max}$  (maximum voltage). Attenuated voltage levels at various terminal endings within the arbor and soma are indicated by arrows and given as fractions of  $V_{max}$ . E: Attenuation at soma of single voltage injection placed at different terminal endings within the dendritic arbor as function of anatomical distance of the voltage injection from the soma. Each voltage injection mimics the activation of a single synapse. The abscissa represents relative anatomical distances normalized to the greatest extent of each arbor, and the plotted points represent values from the four cells shown in A–D. [From Bloomfield and Sherman, 1989.]

of their dendritic branches. These branches closely adhere to Rall's "3/2 branching rule" (Bloomfield et al., 1987). This states that the diameters of the daughter dendrites each raised to the 3/2 power and summed equals the diameter of the parent dendrite raised to the 3/2 power (Rall, 1977). Such branching matches impedance on both sides of the branch point and permits efficient current flow across these branches in both directions. This maximizes the transmission of distal postsynaptic potentials to the soma. This also implies that a potential generated anywhere in the dendritic arbor or at the soma will be efficiently transmitted throughout the dendritic arbor. Among other things, this means that the discharge of an action potential will depolarize the entire dendritic

arbor by tens of millivolts, and this could have significant effects on voltage-dependent processes in the dendrites (see Membrane Properties).

#### INTERNEURONS

Unlike relay cells, interneurons are not electrotonically compact (Bloomfield and Sherman, 1989). This is in part because their dendrites are thinner and longer than those of relay cells. More importantly, the dendritic branch points of interneurons violate the "3/2 branching rule," because daughter branches tend to be too thin. This limits the current flowing across these branch points. As a result, *providing that there are no major active conductances in the dendritic arbor of interneurons*, much of the synaptic circuitry in distal dendrites, including that involving the F2 terminals, would be functionally isolated from the soma and axon (see Fig. 8.11). We emphasize the proviso here concerning the assumption of no significant  $\text{Ca}^{2+}$  and  $\text{Na}^{+}$  conductances in the dendrites, and this attribute remains unknown. Ralston (1971) proposed some time ago that synaptic input onto the axoniform dendritic (F2) terminals of interneurons in the cat's ventral posterior lateral nucleus would also be isolated from the soma. Other examples of this property are found in the olfactory bulb (see Chap. 5) and retina (see Chap. 6).

Computational modeling based on these observations and with the assumption of passive cable properties suggests an interesting mode of operation for these interneurons (Sherman, 1988; Bloomfield and Sherman, 1989), shown schematically in Fig. 8.12. Clusters of dendritic appendages, which are major sites of input and output, represent local circuits whose computations are largely independent of activity in other clusters and in the soma. In contrast, the axonal output is controlled in a more orthodox manner by input to the soma and proximal dendrites. This output appears to be mediated by conventional action potentials (Sherman and Friedlander, 1988). Also, although the dendritic F2 outputs innervate relay X cells through glomeruli, the axon forms F1 terminals that innervate dendritic shafts outside of glomeruli of relay X and Y cells (Hamos et al., 1985; Montero, 1987; Sherman and Friedlander, 1988; Wang et al., 2001). This suggests that the interneuron simultaneously does double duty: integration of the axonal F1 outputs via action potentials depends on one set of proximal inputs and involves one type of postsynaptic target, whereas integration of the dendritic F2 outputs depends on local inputs and involves different postsynaptic targets.

#### MEMBRANE PROPERTIES

The integrative characteristics of neurons are heavily dependent on their intrinsic electrophysiological properties (see Chap. 2). We can no longer view a thalamic cell as being a simple response element that linearly sums its synaptic inputs to determine its axonal output. Thus cable modeling as described earlier is only a beginning toward explaining how a neuron responds to various synaptic inputs. In reality, these cells have a variety of active membrane conductances. Many of these are controlled by ligand binding of neurotransmitters, including effects of second messenger pathways activated by metabotropic receptors, but some are controlled by membrane voltage and others are controlled by concentration levels of certain ions, such as  $\text{Ca}^{2+}$ .

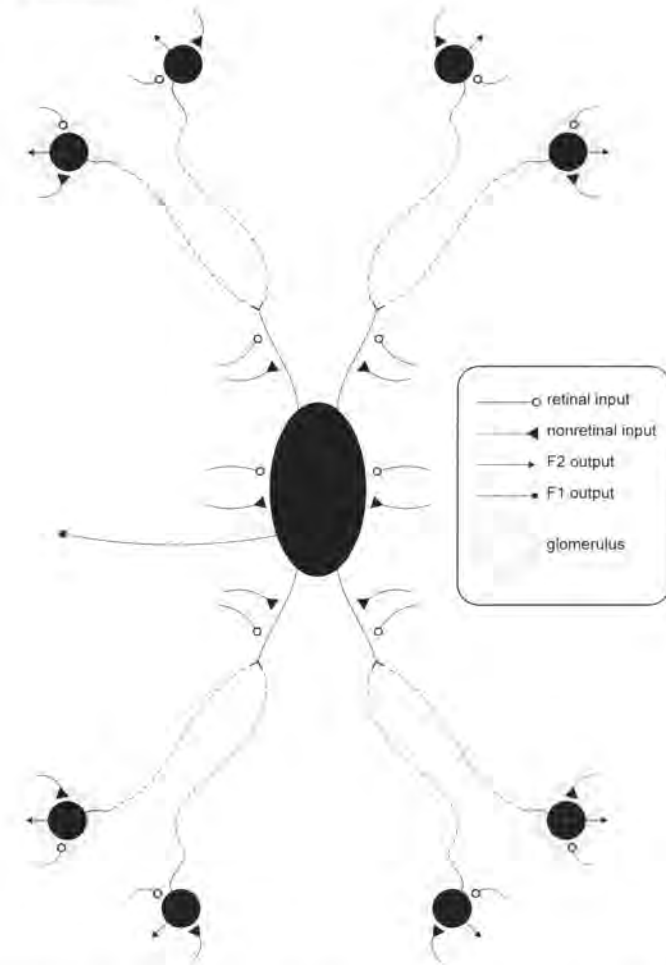

Fig. 8.12. Schematic view of hypothesis for functioning of interneurons in the lateral geniculate nucleus of the cat. Retinal and nonretinal inputs are shown both to the distal dendrites, associated with glomeruli, as well as to the proximal dendrites and soma. The glomerular inputs lead to F2 outputs from the dendrites, whereas the inputs to the proximal dendrites and soma lead to F1 outputs from the axon. The dashed lines indicate the electrotonic isolation between glomeruli and the proximal dendrites plus soma. This isolation suggests that the two sets of synaptic computations, peripheral for the glomerular F2 outputs and proximal for the axonal F1 outputs, transpire in parallel and independently of one another. Most glomeruli are also functionally isolated from one other. [Redrawn from Sherman and Guillery, 2001.]

Both *in vitro* and *in vivo* experiments of different thalamic nuclei across several mammalian species have revealed a surprising plethora of intrinsic membrane conductances present in *all* thalamic neurons, both in the dorsal thalamus nuclei and within reticular neurons (Steriade et al., 1987; Steriade and Llinás, 1988; Huguenard and McCormick, 1992; McCormick and Huguenard, 1992). These conductances all lead to currents that alter the membrane potential. The number of active conductances de-

scribed for thalamic neurons continues to grow. Which conductances are active can greatly affect how a thalamic neuron's input is relayed to cortex. Conductances found in thalamic neurons are generally found in many other brain cells as well, and for the most part these have been described in detail in Chap. 2. The major and best understood ones operating in thalamic neurons are listed below (see also Chap. 2).

#### Na<sup>+</sup> CONDUCTANCES

Two voltage-dependent Na<sup>+</sup> conductances have been described. The fast, inactivating Na<sup>+</sup> conductance, similar to the one described by Hodgkin and Huxley (1952) for the squid giant axon, is voltage dependent and subserves the conventional action potential. The other Na<sup>+</sup> conductance is persistent and noninactivating. This creates a plateau depolarization that serves to inactivate certain currents, such as I<sub>A</sub> and I<sub>T</sub> (see next paragraphs).

#### Ca<sup>2+</sup> CONDUCTANCES

There are at least two voltage-dependent Ca<sup>2+</sup> conductances. One has a high threshold and is most likely located in the dendrites; rather little is known about this conductance. The other, also located in the dendrites, has a lower threshold and plays a dramatic role in retinogeniculate transmission (and the transmission of other driving inputs in other thalamic relays). It is often known as the *low threshold Ca<sup>2+</sup> conductance* and is described more fully here. It operates via T (for transient)-type Ca<sup>2+</sup> channels. When the channels open, the resultant conductance leads to Ca<sup>2+</sup> entry, represented by an inward current known as I<sub>T</sub>, thereby depolarizing the cell and producing the *low threshold spike*. Thus the low threshold Ca<sup>2+</sup> conductance, the low threshold spike, and I<sub>T</sub> are all part of the same process. The low threshold spike is an all-or-none spike (Zhan et al., 1999), much like the conventional action potential, propagating throughout the dendritic arbor. It is important to note that this channel is absent in appreciable numbers from the axon, and thus the low threshold spike is not propagated up the axon to cortex. Low threshold spikes are found in every relay cell of every thalamic nucleus of every mammalian species so far studied (reviewed in Sherman and Guillery, 1996). These spikes also occur in cells of the thalamic reticular nucleus and interneurons, although their prevalence in interneurons remains controversial (see K<sup>+</sup> Conductances).

Apart from those underlying the generation of conventional action potentials, the low threshold Ca<sup>2+</sup> conductance is probably the most important conductance for relay cells. Details of its properties can be found elsewhere (Jahnsen and Llinás, 1984a,b; McCormick and Feese, 1990; Huguenard and McCormick, 1992; McCormick and Huguenard, 1992) and are summarized here. Figure 8.13 shows the voltage dependence of the T channels and those of K<sup>+</sup> channels, which are also involved in the generation of the low threshold spikes. The T channels have two voltage-sensitive gates, an activation gate and an inactivation gate, and both must be open for Ca<sup>2+</sup> to flow into the cell to generate I<sub>T</sub>. At relatively hyperpolarized resting membrane potentials (Fig. 8.13,1), the activation gate is closed but the inactivation gate is open, so I<sub>T</sub> is *de-inactivated*. The single gate of the K<sup>+</sup> channel is closed at this membrane potential. If the cell is now sufficiently depolarized (e.g., by an EPSP), the activation gate opens, and Ca<sup>2+</sup> flows into the cell, generating I<sub>T</sub> and providing the upswing of the low threshold spike (Fig. 8.13,2). However, depolarization eventually closes the inactivation gate af-

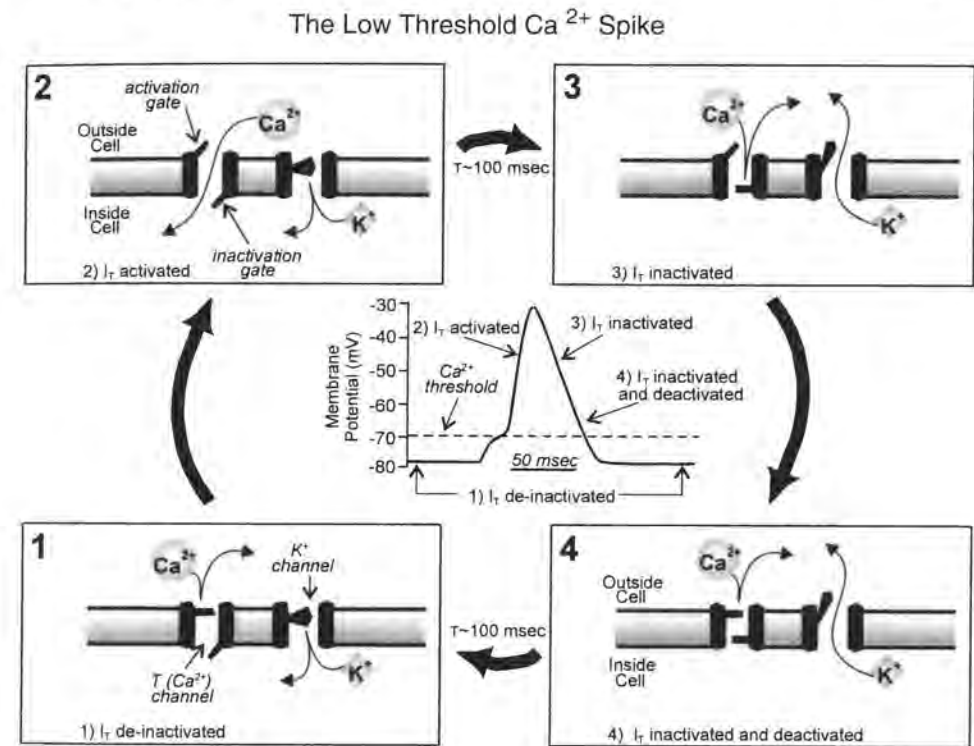

Fig. 8.13. Schematized view of actions of voltage-dependent T (Ca<sup>2+</sup>) and K<sup>+</sup> channels underlying low threshold Ca<sup>2+</sup> spike. The four numbered panels show the sequence of channel events, and the central graph shows the effects on membrane potential. The T channel has two voltage-dependent gates: an *activation* gate that opens with depolarization and closes at hyperpolarized levels and an *inactivation* gate that shows the opposite voltage dependency. The K<sup>+</sup> channel shown is really a conglomeration of several such channels that have only a single gate that opens during depolarization; thus, these channels do not inactivate. (1) At a relatively hyperpolarized resting membrane potential ( $\approx -70$  mV), the activation gate of the T channel is closed, but the inactivation gate is open, and so the T channel is *de-inactivated*. The single gate for the K<sup>+</sup> channel is closed. (2) With sufficient depolarization to reach its threshold, the activation gate of the T channel opens, and Ca<sup>2+</sup> flows into the cell. This further depolarizes the cell, providing the rise of the low threshold spike. (3) The inactivation gate of the T channel closes after being depolarized for roughly 100 msec ("roughly" because closing of the channel is a complex function of voltage and time), and the K<sup>+</sup> channel also opens. These actions repolarize the cell. When the inactivation gate of the T channel is closed, the channel is *inactivated*. (4) Even though the initial resting potential is reached, the T channel remains *inactivated*, because it takes roughly 100 msec ("roughly" having the same meaning as before) of hyperpolarization to *de-inactivate* it; it also takes a bit of time for the various K<sup>+</sup> channels to close. Note that the behavior of the T channel is qualitatively exactly like the Na<sup>+</sup> channel involved with the action potential but with several quantitative differences: the T channel is slower to inactivate and *de-inactivate*, and it operates in a more hyperpolarized regime.

ter  $\approx 100$  msec (Fig. 8.13,3). Actually, the opening or closing of the inactivation gate is a complex function of voltage and time (Jahnsen and Llinás, 1984a,b) so that the more depolarized (or hyperpolarized), the more quickly the gate closes (or opens), but the important point is that under normal conditions,  $\approx 100$  msec is required for these actions. Thus I<sub>T</sub> is *inactivated*. The single gate of the voltage- and Ca<sup>2+</sup>-dependent K<sup>+</sup>

channel also opens, and the combined inactivation of  $I_T$  and activation of the  $K^+$  channels repolarizes the cell (Fig. 8.13,4). Although the membrane is repolarized to its initial potential,  $I_T$  remains inactivated, because it takes  $\approx 100$  msec of this hyperpolarization to remove the inactivation of  $I_T$  (and thus  $I_T$  is *de-inactivated*), after which, the initial conditions are re-established (Fig. 8.13,1). To reiterate: when the cell is sufficiently hyperpolarized for more than about  $\approx 100$  msec,  $I_T$  is de-inactivated; if de-inactivated, a suitable depolarization can then activate  $I_T$ , but continued depolarization for more than  $\approx 100$  msec will inactivate it; the inactivation can then be removed by suitable hyperpolarization for more than about 100 msec.

Note that the voltage-dependent properties of the T channels are qualitatively identical to those of the  $Na^+$  channels underlying the action potential, but there are important quantitative differences: (1) the T channels are found in the soma and dendrites, but not in the axon, and thus the low threshold spike can be propagated through the dendrites and soma, but not along the axon to cortex. Nonetheless, the T channels can affect the message reaching cortex by the effect of the low threshold spike on action potential generation (see Burst and Tonic Relay Response Modes). (2) Opening or closing of the inactivation gate is roughly two orders of magnitude faster for the  $Na^+$  channel. (3) The T channels operate in a somewhat more hyperpolarized regime.

Figure 8.14 shows some of the functional consequences of  $I_T$  in recordings from relay cells of the cat's lateral geniculate nucleus. When the membrane is more depolarized than roughly  $-60$  to  $-65$  mV for  $> \approx 100$  msec,  $I_T$  becomes inactivated (Fig. 8.14A), and activation by a depolarizing pulse evokes a steady stream of unitary action potentials that lasts for the duration of the stimulus: this is the *tonic mode* of firing, which prevails when  $I_T$  is inactivated.

"Tonic" used in this sense refers to a response mode of a thalamic relay cell, and here it is paired with "burst." All thalamic relay cells, including the X and Y cells in the A-laminae of the cat's lateral geniculate nucleus, display both response modes. However, for a functional categorization of the X and Y cells, "tonic" X cells are often contrasted with "phasic" Y cells. This is an entirely different use of "tonic," and the two should not be confused. Throughout this account, we shall use "tonic" only to refer to response mode, not to cell type.

When the membrane is more hyperpolarized than about  $-65$  to  $-70$  mV for  $> \approx 100$  msec (see Fig. 8.14B),  $I_T$  becomes de-inactivated. The identical depolarizing pulse now activates  $I_T$ , leading to a low threshold spike, which in turn activates a burst of several action potentials: this is the *burst mode* of firing, which prevails when  $I_T$  is de-inactivated and then activated.

#### $K^+$ CONDUCTANCES

A number of voltage- and  $Ca^{2+}$ -dependent  $K^+$  conductances exist that give rise to various membrane currents (see Chap. 2). The best known is the *delayed rectifier* ( $I_K$ ), which is part of the action potential and repolarizes the neuron following the  $Na^+$  conductance. Several others ( $I_A$ ,  $I_C$ , and possibly  $I_{AHP}$ ) hyperpolarize the neuron for varying lengths of time following a conventional action potential. The amount of this hyperpolarization determines the cell's relative refractory period, which limits its maximum firing rate. Finally, thalamic cells exhibit a variable, voltage-independent  $K^+$  "leak" current, which, in addition to other such "leak" currents for  $Na^+$ ,  $Cl^-$ , etc., determine the resting membrane potential.

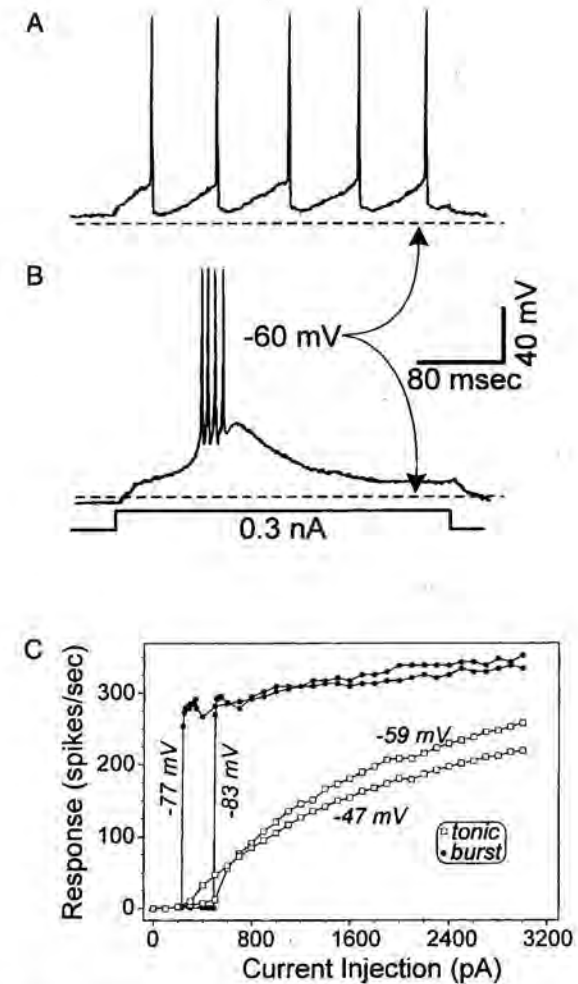

Fig. 8.14. Properties of burst and tonic firing for relay cells of the cat's lateral geniculate nucleus recorded intracellularly *in vitro*. **A** and **B**: Voltage dependency of the low threshold spike for one cell. Responses are shown to the same depolarizing current pulse administered intracellularly but from two different initial holding potentials.  $I_T$  is inactivated with relative depolarization (**A**), and the response is a succession of unitary action potentials for the duration of the suprathreshold stimulus. This is the *tonic mode* of firing.  $I_T$  is de-inactivated with relative hyperpolarization (**B**), and the response is a low threshold spike with 4 action potentials riding its crest. This is the *burst mode* of firing. **C**: Input-output relationship for another cell. The abscissa plots the amplitude of the depolarizing current pulse, and the ordinate plots the evoked firing frequency based on the first 6 action potentials of the response, because this cell usually exhibited 6 action potentials per burst in this experiment. The initial holding potentials are shown:  $-47$  mV and  $-59$  mV reflect tonic mode, whereas  $-77$  mV and  $-83$  mV reflect burst mode. [Redrawn from Sherman and Guillery, 2001.]

$I_A$  and its relationship with  $I_T$  is particularly interesting. The voltage dependencies of these two currents are generally similar in that both are inactive at depolarized  $V_m$  and can be activated by depolarization from relatively hyperpolarized  $V_m$ . However, although  $I_T$  leads to depolarization due to  $Ca^{2+}$  entry,  $I_A$  leads to hyperpolarization due to  $K^+$  leaving the cell. Because  $I_A$  is activated by depolarization, this means that it will oppose that depolarization, making it smaller and slowing it down. However, for most relay cells, the activation and inactivation curves of  $I_T$  are offset by at least 10 mV in the hyperpolarized direction with respect to those of  $I_A$  (Pape et al., 1994). This means that, when a relay cell is hyperpolarized sufficiently to de-inactivate both currents and then is depolarized,  $I_T$  will activate before  $I_A$ , and the resultant spike-like depolarization will rapidly inactivate  $I_A$  before it has a chance to develop. It may thus be uncommon to activate  $I_A$  in relay cells under most conditions. However, there is a narrow window of  $V_m$  in which  $I_T$  is largely inactivated and  $I_A$  is largely de-inactivated, and depolarization that occurs within this limited membrane voltage range will activate  $I_A$  but not  $I_T$ .

There is evidence that this pattern is different in interneurons (Pape et al., 1994), because the voltage dependencies of  $I_T$  and  $I_A$  largely overlap. Thus  $I_A$  and  $I_T$  will tend to be activated together, but the effect of  $I_A$  in offsetting and slowing the depolarization will prevent full expression of  $I_T$ . The result is that interneurons should rarely express  $I_T$  (Pape et al., 1994). However, Zhu et al. (1999) have shown that bursting from low threshold spikes can be elicited in interneurons if a larger activating pulse is given sufficient to overcome  $I_A$ .

#### HYPERPOLARIZATION-ACTIVATED CONDUCTANCE

A conductance that is activated by membrane hyperpolarization and inactivated by depolarization is often associated with the low threshold  $Ca^{2+}$  conductance. This *hyperpolarization-activated cation conductance*, leads, via influx of cations, to a depolarizing current, which is called  $I_h$  (McCormick and Pape, 1990b). Activation is slow, with a time constant of  $>200$  msec. The combination of  $I_T$ , the above mentioned  $K^+$  conductances, and  $I_h$  helps to support rhythmic bursting, typically at 3–10 Hz for the low threshold spikes, which is often seen in recordings from *in vitro* slice preparations of thalamus. Hyperpolarizing a cell will activate  $I_h$ , but so slowly that  $I_T$  fully de-inactivates. Once  $I_h$  is activated, it will depolarize the cell, thereby activating  $I_T$ . This in turn inactivates both  $I_h$  and  $I_T$  while activating  $K^+$  conductances, resulting in repolarization. The cycle then repeats. This leads to prolonged rhythmic bursting. This bursting can be interrupted only by a sufficiently strong and prolonged depolarization to produce tonic firing, and appropriate membrane voltage shifts can effectively switch the cell between rhythmic bursting and tonic firing. The significance of these different response modes in thalamic function is considered more fully later.

### SYNAPTIC TRANSMISSION

#### IONOTROPIC AND METABOTROPIC RECEPTORS

Inputs to thalamus operate via conventional chemical synapses, and these in turn influence their postsynaptic targets through transmitter interactions with postsynaptic receptors. As discussed in Chap. 2, these receptors can be divided into two basic types:

#### Chapter 8. Thalamus

*ionotropic* and *metabotropic*, and both types are found in thalamus (see Fig. 8.3). Although many differences between these receptor types exist, only a few concern us here (for details, see Chap. 2). Ionotropic receptors include AMPA ( $[±]-α$ -amino-3-hydroxy-5-methylisoxazole-4-propionic acid) and NMDA (*N*-methyl-D-aspartate) receptors for glutamate,  $GABA_A$ , and nicotinic receptors for acetylcholine, and these are directly linked to specific ion channels. Transmitter binding leads to a rapid conformational change that opens an ionic channel and produces a postsynaptic potential that is fast, with a short latency ( $<1$  msec) and a brief duration (few tens of milliseconds). Metabotropic receptors include various metabotropic glutamate receptors,  $GABA_B$ , and various muscarinic receptors for acetylcholine. These are not directly linked to ion channels. Instead, transmitter binding produces a series of biochemical reactions that ultimately leads to the opening or closing of an ion channel, which, for thalamic cells, is usually a  $K^+$  channel; when opened, this produces an IPSP as  $K^+$  flows out of the cell and, when closed, produces an EPSP as  $K^+$  leakage is reduced. These postsynaptic responses are slow, with a long latency ( $≥10$  msec) and a prolonged duration (hundreds of milliseconds or more).

The time course of receptor activation is important with regard to control of  $I_T$  and other voltage- and time-dependent processes. Recall that inactivation or de-inactivation of  $I_T$  requires that a depolarization or hyperpolarization, respectively, be maintained for  $≈>100$  msec. This means that the short-lived postsynaptic potentials of ionotropic receptors are ill suited to control the inactivation state of  $I_T$ . In contrast, the sustained responses associated with metabotropic receptors are ideally suited for this. That is, EPSPs from activation of metabotropic glutamate or muscarinic receptors are sufficiently sustained to inactivate  $I_T$ , and IPSPs from activation of  $GABA_B$  receptors are sufficiently sustained to de-inactivate  $I_T$ .

Fig. 8.3 shows the transmitters and associated receptor types for the various inputs to thalamus.

#### GLUTAMATERGIC INPUTS

The retinal and cortical inputs to thalamus are both glutamatergic.

*Retinogeniculate (and Other Driving) Inputs.* Retinogeniculate axons innervating relay cells (and driving inputs innervating relay cells in other nuclei) activate ionotropic receptors only, not metabotropic ones (Salt and Eaton, 1991; McCormick and Von Krosigk, 1992; Eaton and Salt, 1996; Godwin et al., 1996a), and both AMPA and NMDA receptors are involved. As explained in Chap. 2, for an EPSP to be generated via an NMDA receptor, two events must occur simultaneously: the presynaptic presence of a glutamate-like neurotransmitter coupled with a postsynaptic depolarization sufficient to unblock the channel. As pointed out in Chap. 1, this enables the NMDA receptor complex to act as a sort of molecular *AND* gate (Koch, 1987).

Studies of the lateral geniculate nucleus *in vitro* suggest that the retinogeniculate EPSP controlling action potentials in interneurons also involves only ionotropic glutamate receptors (Pape and McCormick, 1995). However, as noted earlier, this input may be limited to retinal synapses onto relatively proximal dendrites, because the retinal inputs to F2 terminals located in the distal dendritic arbor may have little influence on the soma and spike generating region of the axon hillock. Indeed, evidence indicates



that the retinal input onto dendritic terminals of interneurons activates metabotropic glutamate receptors and possibly also AMPA receptors (Godwin et al., 1996a; Cox and Sherman, 2000).

*Corticogeniculate Inputs From Layer 6.* Corticogeniculate axons from layer 6 synapsing onto relay cells appear to activate the same types of ionotropic receptors as do retinogeniculate axons. However, in addition to these, the axons from cortex also activate a *metabotropic* glutamate receptor on relay cells (McCormick and Von Krosigk, 1992; Eaton and Salt, 1996; Godwin et al., 1996a; Golshani et al., 1998).

Indirect evidence suggests that layer 6 cortical inputs to interneurons also activate only ionotropic glutamate receptors. That is, the application of metabotropic glutamate agonists does not affect the firing of interneurons (Pape and McCormick, 1995; Cox and Sherman, 2000), suggesting that there are no metabotropic glutamate receptors on proximal dendrites, and this is consistent with immunocytochemical evidence (Godwin et al., 1996a). Also, cortical inputs do not innervate F2 terminals, where metabotropic glutamate receptors are found and are apparently postsynaptic to retinal and cholinergic brainstem inputs (Godwin et al., 1996a; Erişir et al., 1997a; Cox and Sherman, 2000).

Both ionotropic and metabotropic receptors are found on reticular cells (Cox and Sherman, 1999), but it is not clear whether the two main glutamatergic inputs—from cortical layer 6 and thalamic relay cells—each activates one or both types of receptor.

#### GABAERGIC INPUTS

Thalamic relay cells receive an inhibitory, GABAergic input from cells of the thalamic reticular nucleus and from interneurons. The postsynaptic response to these inputs involves both GABA<sub>A</sub> (ionotropic) and GABA<sub>B</sub> (metabotropic) receptors (see Chap. 2 for details of IPSPs related to these receptor types).

As noted earlier, reticular cells can respond in both tonic and burst modes. However, on the relay cell, the postsynaptic effect of these modes can be quite different, because tonic firing primarily activates only GABA<sub>A</sub> receptors, whereas burst firing often activates GABA<sub>B</sub> receptors (Kim et al., 1997; Kim and McCormick, 1998). This is because a cluster of high frequency action potentials in an input is often required to activate metabotropic receptors, whereas single action potentials can often activate ionotropic receptors alone. The difference in the postsynaptic effect in relay cells is that tonic firing of reticular cells will presumably evoke a series of fast and brief IPSPs in the relay cells, but burst firing will evoke slow, prolonged IPSPs. The additional importance of this for firing mode in relay cells is considered in Control of Response Mode.

The functional significance of interneuronal activity is more complicated for two reasons. First, as noted earlier, the question of how common it is for interneurons to fire in burst mode remains controversial. Second, most synaptic outputs of interneurons are dendritic. Clearly, the axonal outputs will follow the firing of the interneuron, but it is not clear what relationship exists between cell firing and the dendritic, F2 terminal activity. If these are electrically isolated from the soma, as has been suggested (Bloomfield and Sherman, 1989; Cox and Sherman, 2000), then there might be no relationship. These F2 terminals might then be controlled solely by local inputs that do not reflect those controlling firing in the cell body and axon hillock. However, it is possible that action potentials in the soma do affect the F2 outputs; for instance, it is

not known whether backpropagation of the action potential exists throughout the dendrites. Thus we are far from understanding how an interneuron's firing affects relay cells.

#### BRAINSTEM INPUTS

*Parabrachial Inputs.* In cats, most of the input to the lateral geniculate nucleus from the brainstem derives from the parabrachial region and is cholinergic (de Lima et al., 1985; de Lima and Singer, 1987; Fitzpatrick et al., 1988b, 1989; Raczkowski and Fitzpatrick, 1989; Bickford et al., 1993). Activation of this input in relay cells produces an excitatory postsynaptic potential due primarily to activation of two different receptors (McCormick and Prince, 1987; McCormick, 1989, 1992). The first is a nicotinic (ionotropic) receptor that produces a fast excitatory postsynaptic potential by permitting influx of cations. The second is an M1 muscarinic (metabotropic) receptor that triggers a slow, long lasting excitatory postsynaptic potential. It seems remarkably similar to the metabotropic glutamate response seen from activation of corticogeniculate input (see Corticogeniculate Inputs From Layer 6), and the possibility exists that both metabotropic receptors may be linked to the same second messenger pathway and K<sup>+</sup> channels.

Activation of the cholinergic inputs from the parabrachial region generally inhibits interneurons and reticular cells (Dingledine and Kelly, 1977; Ahlsén et al., 1984; McCormick and Prince, 1987; McCormick and Pape, 1988). This is interesting, because individual parabrachial axons branch to innervate both of these cell groups as well as relay cells and, as noted earlier, these axons excite relay cells. This is accomplished by yet another type of muscarinic receptor, M2, that dominates on these GABAergic targets (McCormick and Prince, 1987; Hu et al., 1989; McCormick, 1989, 1992). Activation of this receptor increases a K<sup>+</sup> conductance, leading to hyperpolarization. The M2 receptor on interneurons is found both on proximal dendrites, allowing parabrachial inputs to affect action potential generation (Plummer et al., 1999; Carden and Bickford, 1999), and on the F2 terminal, which inhibits release of GABA there (Cox and Sherman, 2000). Cells of the thalamic reticular nucleus also respond to this cholinergic input with another, nicotinic receptor that leads to fast depolarization (Lee and McCormick, 1995). Nonetheless, the main effect of cholinergic stimulation of these cells seems to be dominated by the muscarinic, inhibitory response (Dingledine and Kelly, 1977; Ahlsén et al., 1984; McCormick and Prince, 1987; McCormick and Pape, 1988). Because these interneurons and reticular cells inhibit relay cells, activation of this cholinergic pathway thus disinhibits relay cells (see Fig. 8.10).

In addition to acetylcholine (ACh), these axon terminals appear to co-localize nitric oxide (Bickford et al., 1993; Erişir et al., 1997a), a neurotransmitter or neuromodulator with a widespread distribution in the brain (Schuman and Madison, 1991, 1994; Snyder, 1992; Brecht and Snyder, 1992). Relatively little is known concerning the action of nitric oxide in the thalamus, but studies suggest that its release from parabrachial terminals serves two possible roles in the lateral geniculate nucleus: to switch response mode from burst to tonic (Pape and Mager, 1992), perhaps complementing the role of ACh in this regard; and to promote the generation of NMDA responses from retinal inputs (Cudeiro et al., 1994a,b, 1996). Nothing is as yet known about the action of nitric oxide on interneurons or reticular cells.

*Other Brainstem Inputs.* Other less well understood brainstem inputs to thalamus include noradrenergic axons from cells in the parabrachial region, serotonergic axons from cells in the dorsal raphe nucleus, and histaminergic axons from cells in the tuberomammillary nucleus of the hypothalamus; other inputs unique to specific thalamic nuclei may also occur, such as the GABAergic input from cells from the pretectum to the lateral geniculate nucleus and from the basal ganglia to the ventral anterior nucleus.

Noradrenaline has two very different effects on relay cells, and these effects act through two metabotropic receptors. One effect, via activation of the  $\alpha_1$  adrenoreceptors, produces a long slow EPSP, which promotes tonic firing, much like activation of metabotropic glutamate or M1 muscarinic receptors. The other effect, which operates through the  $\beta$  adrenoreceptors, changes the voltage dependency of  $I_h$  in such a way as to increase this depolarizing, voltage-dependent current.

*In vitro* studies suggest that application of serotonin has no conventional inhibitory or excitatory effect on relay cells (McCormick and Pape, 1990a). However, by operating through an unknown but probably metabotropic receptor, serotonin has the same effect on  $I_h$  as that described earlier for noradrenaline (McCormick and Pape, 1990a).

The application of histamine to geniculate relay cells has nearly identical effects to noradrenergic application (McCormick and Williamson, 1991). One effect, operating through an H1 metabotropic receptor, produces a long slow EPSP that also promotes tonic firing (see also Uhrich et al., 2002). The other effect, which operates through an H<sub>2</sub> metabotropic receptor, changes  $I_h$  in the same way as do noradrenaline and serotonin.

### GATING AND OTHER TRANSFORMATIONS IN THE THALAMIC RELAY

The rich array of membrane properties of thalamic relay cells plus their complex ensemble of inputs from various sources suggests that the relay of peripheral information to cortex is not a simple, or trivial, affair. Instead, it is a complex process that we are just beginning to understand. This is a marked change from earlier views of, for instance, the lateral geniculate nucleus, which was thought to provide a simple, machine-like relay of retinal information to cortex with minor processing added. This will be considered in more depth here both in terms of the different burst and tonic response modes introduced earlier and the role they play in the thalamic relay and also in terms of what we are just beginning to learn about the role of cortical and brainstem inputs in this relay.

#### BURST AND TONIC RELAY RESPONSE MODES

*Signal Transmission During Burst and Tonic Firing.* Burst and tonic modes clearly represent two very different types of response to afferent input and thus two very different forms of thalamic relay. In fact, earlier studies suggested that tonic firing represented the only true relay mode and that burst firing, when it occurred, was always characterized by *rhythmic* bursting that was synchronized across large regions of thalamus. This functionally disconnected the relay cell from its primary afferent input, thereby interrupting the relay (Steriade and Llinás, 1988; McCormick and Feeseer, 1990; Steriade and McCarley, 1990; Le Masson et al., 2002). The idea was that switching between these modes was accomplished by inputs that changed  $V_m$ . Rhythmic bursting was of-

ten seen *in vitro*, and the first *in vivo* studies of the response modes in cats demonstrated that, when the animal entered quiet or non-REM sleep, thalamic relay cells began to burst rhythmically, and that such rhythmic bursting was not seen during awake, alert states (Livingstone and Hubel, 1981; Steriade and Llinás, 1988; Steriade and McCarley, 1990; Steriade et al., 1990, 1993; Steriade and Contreras, 1995).

However, more recent data in lightly anesthetized and awake, behaving animals, including awake humans (reviewed in Sherman, 2001), makes it clear that relay cells can burst arrhythmically and asynchronously in these states and that relay cells in the lateral geniculate nucleus and ventral posterior lateral and medial nuclei still respond in burst mode to sensory stimulation (Fanselow et al., 2001; Swadlow and Gusev, 2001; Nicolelis and Fanselow, 2002). The best examples of such burst responses come from geniculate cells. During spontaneous activity, the cells may often discharge a low threshold spike with a burst response, but these burst discharges occur irregularly. When the cell is then stimulated visually, the cell may produce a burst in response to each presentation of the stimulus, and the bursting under these conditions clearly reflects the external stimulus rather than any intrinsic pacemaker (Guido et al., 1992, 1995; Guido and Weyand, 1995; Mukherjee and Kaplan, 1995; Godwin et al., 1996b; Sherman, 1996, 2001; Ramcharan et al., 2000).

There are thus three different recognizable response modes: rhythmic bursting, arrhythmic bursting, and tonic firing. The first occurs during quiet or non-REM sleep and might also occur during epileptic episodes (Steriade and Llinás, 1988; Steriade and McCarley, 1990); this seems to be associated with an interruption of the relay through thalamus.

The last two occur during the awake state, including drowsiness and fully alert conditions, meaning that both burst and tonic modes can be effective relay modes. However, they differ in the nature of the information relayed. This can be seen with respect to the linearity and signal detectability of the messages relayed to cortex.

*Linearity.* Note in Fig. 8.14A,B that the very same excitatory stimulus produces two very different signals relayed to cortex, and the difference depends on initial membrane potential of the relay cell, because this determines the inactivation state of  $I_T$ . The stimulus in this example is a current pulse, but the same would apply to a sufficiently large EPSP. Because, as noted earlier, the low threshold spike is activated in an all-or-none manner, a larger EPSP will not produce a larger low threshold spike and thus will not produce a larger burst of action potentials (Zhan et al., 2000). This underlies an important difference in input/output relationships between burst and tonic firing, as shown in Fig. 8.14C. This relationship is fairly linear for tonic firing but highly nonlinear for burst firing.

This linearity difference is also seen in the responses of geniculate relay cells to visual stimuli. A clear example is shown in Fig. 8.15A,B, which shows the responses to a drifting sinusoidal grating of a relay cell recorded *in vivo* in an anesthetized cat. When in tonic mode, the cell responds to the grating with a sinusoidal profile (Fig. 8.15D, lower). This means that the response level closely matches the changes in contrast, indicating a very linear relay of this input to cortex. However, when the same stimulus is applied to the same cell, but now in burst mode, the response no longer looks sinusoidal (Fig. 8.15B, lower), indicating considerable nonlinear distortion in the relay.

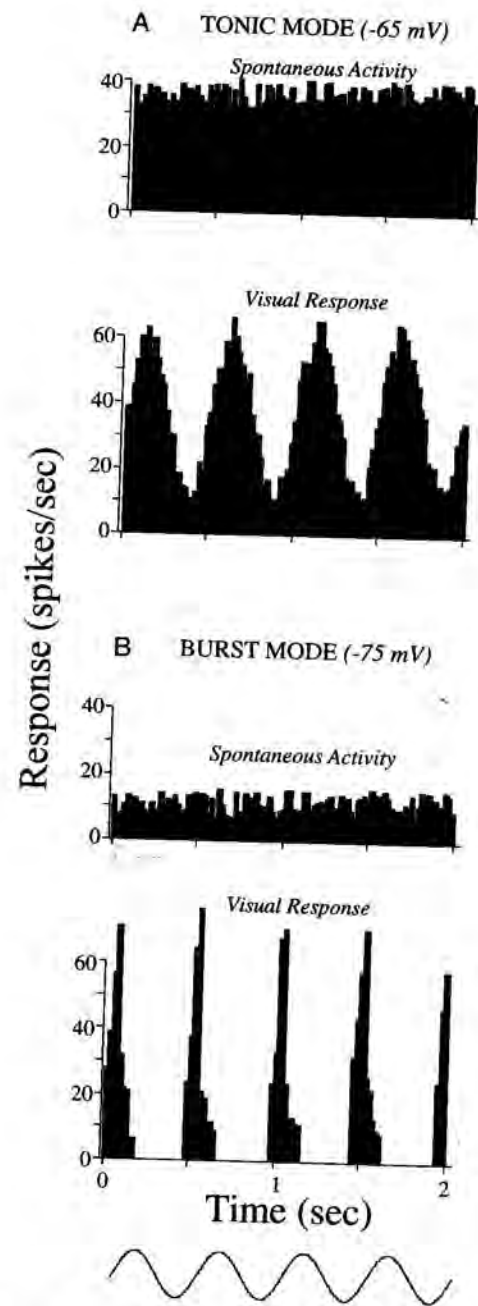

Fig. 8.15. Properties of burst and tonic firing for a relay cell of the cat's lateral geniculate nucleus recorded intracellularly *in vivo*. **A** and **B**: Tonic and burst responses to visual stimulation. Shown in each condition are average response histograms during spontaneous activity (upper) and to four cycles of a drifting sinusoidal grating (lower). The sinusoidal contrast changes resulting from the drifting grating are shown below the histograms. Current injected through the recording electrode was used to bias membrane potential to more depolarized ( $-65$  mV), producing tonic firing (**A**), or more hyperpolarized ( $-75$  mV), producing burst firing (**B**). [Redrawn from Sherman and Guillery, 2001.]

Thus tonic mode is better at preserving linearity in the relay of information to cortex (Sherman, 1996, 2001).

**Detectability.** The upper histograms of Fig. 8.15A,B show further that spontaneous activity is lower during burst than during tonic firing. Higher spontaneous activity helps to preserve response linearity, because it minimizes rectification of the response to inhibitory phases of visual stimulation, and rectification is a nonlinearity. Perhaps more interesting is the notion that spontaneous activity represents firing without a visual stimulus and can thus be considered a noisy background against which the signal—the response to the visual stimulus—must be detected. Therefore, the signal-to-noise ratio is higher during burst firing, and a higher signal-to-noise ratio implies greater stimulus detectability. This has been confirmed through the use of a method from signal detection theory involving the calculation of *receiver operating characteristic* curves (Green and Swets, 1966; Macmillan and Creelman, 1991) showing that stimulus detectability is improved during burst firing compared with tonic firing (Sherman, 1996, 2001).

**Bursting as a “Wake-up Call.”** These differences in firing modes concerning linearity and detectability suggest the following hypothesis (Sherman, 1996, 2001). The tonic mode is better for an accurate and faithful relay, because it minimizes the nonlinear distortions created during burst firing. However, the burst mode is better for initial stimulus detectability. As one example, it might be useful during drowsiness to have geniculate relay cells in burst mode to maximize detection of a novel visual stimulus, and after detection, the relay can be switched to tonic firing for more faithful stimulus analysis (for details of this hypothesis, see Sherman, 1996, 2001). Indeed, bursting is more common during drowsiness than during fully alert behavior (Ramcharan et al., 2000; Swadlow and Gusev, 2001), perhaps to maximize the chance of detecting a novel stimulus. Also consistent with this is evidence from studies of the somatosensory thalamus of awake, behaving rabbits that relay cells in burst mode are much more likely to activate their cortical target cells and produce a larger pattern of active cells in cortex than when these relay cells fire in tonic mode (Swadlow and Gusev, 2001; Swadlow et al., 2002). Nonetheless, this notion of bursting as a “wake-up call” remains a hypothesis requiring further testing.

**Control of Response Mode.** Part of this hypothesis requires thalamic circuitry capable of controlling firing mode, and the circuitry shown in Fig. 8.5 provides this requirement. As noted earlier, to switch between response modes means changing the inactivation state of  $I_T$ , and this requires a change in membrane voltage that must be sustained for  $\geq 100$  msec. Thus a sustained depolarization inactivates  $I_T$ , switching the response mode from burst to tonic, and a sustained hyperpolarization de-inactivates  $I_T$ , switching the response mode from tonic to burst. Inputs that activate only ionotropic receptors (i.e., driver inputs) produce mainly fast PSPs poorly suited to this task, because without extensive temporal summation, the evoked changes in membrane polarization would be too transient to affect the inactivation state of  $I_T$  significantly. However, inputs that activate metabotropic receptors (e.g., all of the modulatory inputs) produce sufficiently sustained PSPs. Thus activation of metabotropic glutamate receptors from cortex or muscarinic receptors from the parabrachial region produces a sustained EPSP that inactivates  $I_T$  and switches the firing mode from burst to tonic. Likewise, activa-

tion of GABA<sub>B</sub> receptors, from reticular and/or interneuronal inputs, produces a sustained IPSP that de-inactivates  $I_T$  and switches the firing mode from tonic to burst (for details, see Sherman and Guillery, 1996, 2001). Evidence indeed exists that activating these various modulatory inputs has these effects on response mode.

Note that the cortical and parabrachial inputs ultimately control firing mode via their direct inputs to relay cells, which promote tonic firing, and their indirect inputs, via reticular and/or interneuron inputs, which promote burst firing. Cortical and parabrachial inputs may have the same cellular effects, but the corticothalamic pathway as well as its reticular and interneuronal relay is topographic and purely unimodal (i.e., visual for the lateral geniculate nucleus, somatosensory for the ventral posterior nucleus, etc.), so that this pathway presumably controls firing mode for discrete thalamic relay cell populations based on such properties as different locations or different class (i.e., X or Y). The parabrachial input is diffusely organized, suggesting more dispersed effects, such as would be relevant for overall levels of attention.

**Anatomical Relationship of Modulator Inputs to T Channels.** Figure 8.8 shows how the various modulator inputs that control  $I_T$  distribute on the dendrites of relay cells. The T channels that underlie  $I_T$  are found throughout the cell body and dendritic membranes but are more numerous and denser on dendrites, including peripheral dendrites (Zhou et al., 1997; Destexhe et al., 1998). Thus brainstem and interneuronal inputs, which are located proximally near retinal inputs, can influence membrane voltage there, which not only affect nearby T channels but are also close enough to retinal inputs to directly influence the establishment of retinal EPSPs. In contrast, cortical and reticular inputs are so distally located that they are likely to have less direct influence on retinal inputs (see Fig. 8.11). Instead, they may mainly affect the postsynaptic cell by controlling membrane voltage where voltage-sensitive ion channels, such as T channels, are localized.

#### OTHER EFFECTS OF NONRETINAL OR MODULATORY INPUTS ON THE THALAMIC RELAY

Although we have focused so far on the role of brainstem and cortical afferents to thalamus in terms of their ability to affect response mode, other roles may be played by these and other inputs regarding thalamic relay properties.

**Inputs From the Thalamic Reticular Nucleus.** Although thalamic neurons may switch between relay and burst modes at any time during awake, alert behavioral states, the burst mode is more common during less alert periods, including drowsiness and quiet or non-REM sleep (McCarley et al., 1983; Steriade and Llinás, 1988; Steriade and McCarley, 1990; Steriade et al., 1990, 1993; Steriade and Contreras, 1995). During such inattentive periods, the EEG in all mammals, including humans, becomes highly synchronized, and fast, rhythmic spike-like electrical phenomena known as *spindles* can be seen (Fig. 8.16). These spindles have a frequency of 7–14 Hz.

This dominant feature of the synchronized EEG is generated in the thalamus (Steriade and Llinás, 1988). Studies of thalamic neurons have shown that all cells of the thalamic reticular nucleus can spontaneously generate rhythmic discharges at a rate of  $\approx 10$  Hz. The low threshold spike appears to be a key feature of this endogenous bursting behavior, and the oscillations can be generated within individual reticular cells.

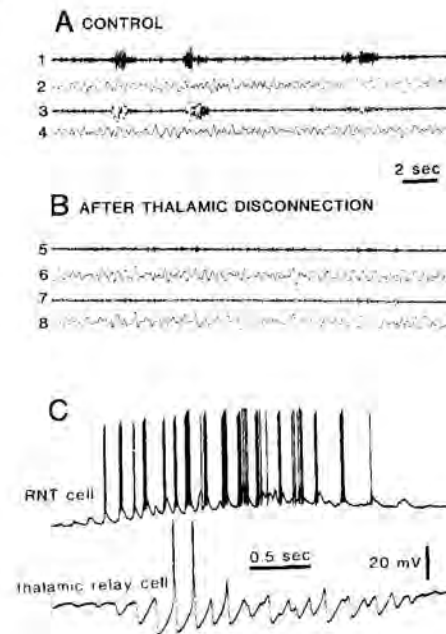

Fig. 8.16. Relationship of thalamus to spindle activity in the cortical electroencephalogram (EEG) of cats. **A** and **B**: Effect on the EEG of rostral thalamic transections that disconnect the thalamus from the cortex. The numbering of traces is as follows: 1 and 5, higher frequency EEG (7–14 Hz) for right hemisphere; 2 and 6, lower frequency EEG (0.5–4 Hz) for right hemisphere; 3 and 7, higher frequency EEG (7–14 Hz) for left hemisphere; 4 and 8, lower frequency EEG (0.5–4 Hz) for left hemisphere. Normally (**A**, before transection), each hemisphere shows activity in both the higher (7–14 Hz) and lower (0.5–4 Hz) filtered traces. After transection (**B**), the higher frequencies are selectively eliminated from the EEG. [Revised from Steriade et al., 1987.] **C**: Activity of thalamic neurons during an EEG spindle. During the spindle, the TRN neuron (top) undergoes a long-lasting, slow depolarization that elevates its firing rate. In contrast, a thalamic relay cell (bottom) is hyperpolarized rhythmically, and the rebound from these hyperpolarizations often lead to low threshold Ca<sup>2+</sup> spikes. The elevated firing in the TRN cell seems to cause the rhythmic hyperpolarizations in the relay cell. [A and B revised from Steriade et al., 1987; C revised from Steriade and Llinás, 1988.]

Also, groups of deafferented reticular neurons can generate such synchronized oscillatory activity in the absence of external input (Steriade et al., 1987; Steriade and Llinás, 1988). Reticular neurons are connected to other reticular cells via collaterals of the axon that innervates dorsal thalamus and by electrical contacts (Landisman et al., 2002), and these connections could serve to synchronize entire reticular regions; dendrodendritic synapses may also exist among reticular neurons to further synchronize these cells (Steriade et al., 1987; Steriade and Llinás, 1988; Pinault et al., 1997).

Because reticular neurons provide an inhibitory, GABAergic input to thalamic relay cells, the thalamic reticular nucleus entrains its oscillatory activity onto these relay cells. That is, the synchronized bursts of reticular activity would lead to waves of hyperpolarization among relay cells; this would de-inactivate low threshold spikes in the relay cells, and they would synchronously enter the burst mode. By themselves, neu-

rons in the lateral geniculate or in other thalamic nuclei do not spontaneously generate spindle rhythmicity; disconnecting the projection cells from the reticular nucleus by surgical or chemical means abolishes the oscillations (Steriade et al., 1987; Steriade and Llinás, 1988). Thus this feature of synchronized, rhythmic bursting among relay cells, which is associated with inattentive and unconscious states and interruption of the thalamic relay, depends critically on the reticular nucleus.

**Brainstem Inputs.** Non-REM sleep and spindle activity is associated with quiescence among many of the cholinergic inputs to the thalamus from the parabrachial region (Steriade and Contreras, 1995). It thus seems plausible that increasing activity of these inputs will serve to terminate the synchronized, rhythmic activity and restore relay cell responses to tonic or arrhythmic burst firing. Indeed, there is ample evidence that activity in brainstem afferents is associated with more alert behavioral states. More to the point, modulatory inputs to the thalamic reticular nucleus from the parabrachial region can inhibit reticular cells and thereby break their hold on relay cells, halting the synchronized, rhythmic bursting and restoring functional relay properties (Le Masson et al., 2002).

There is also evidence that eye movements can affect the geniculate relay (Büttner and Fuchs, 1973; Noda, 1975; Bartlett et al., 1976; Lal and Friedlander, 1989; Guido and Weyand, 1995; Ramcharan et al., 2001). Both saccades and passive movement of the eye can have such effects. Although the details for this have yet to be worked out, it seems likely that these effects are accomplished via brainstem afferents to thalamus.

**Cortical Inputs From Layer 6.** As noted earlier, the corticogeniculate input is both massive and heterogeneous. It is thus plausible that it subserves several distinct functions. Perhaps this is why earlier attempts to identify any *single* function for this "feedback" pathway have led to confusing and conflicting conclusions. For instance, some studies suggest that the corticogeniculate pathway facilitates relay cell firing, whereas others suggest the opposite (Kalil and Chase, 1970; Baker and Malpeli, 1977; Schmielau and Singer, 1977; Geisert et al., 1981; McClurkin and Marrocco, 1984; McClurkin et al., 1994). The large number of layer 6 inputs suggests that this feedback could be highly specific to receptive field location, orientation, direction of motion, and ocularity. Mumford (1994) has developed a detailed framework, based on ideas from machine vision, in which the detection of weak or incomplete stimuli under noisy conditions (think of a gray mouse at dusk viewed by a cat) would be enhanced by such feedback. In this context, it should be pointed out that the vast majority of experiments carried out in the lateral geniculate nucleus have involved anesthetized animals stimulated with single bars or gratings on a blank background, not a situation that might be expected to activate the type of feedback function suggested by Mumford (1994).

Schmielau and Singer (1977) have proposed that corticogeniculate input is important to binocular functions, such as stereopsis. Several studies have identified a role for the corticogeniculate input in controlling inhibitory surrounds of geniculate relay cells (reviewed in Sillito and Jones, 2002). More recent studies have suggested that the pathway affects temporal properties of relay cell discharges (McClurkin et al., 1994) or establishes correlated firing among nearby relay cells with similar receptive field properties (Sillito et al., 1994). Earlier we suggested that this input serves to control

response mode, tonic or burst, of the relay cells. Given the likelihood that the corticogeniculate pathway is heterogeneous, these different suggestions for its function are not incompatible, and more functions may yet emerge.

A recent study suggests an additional possible role for layer 6 cortical input. When fairly balanced excitatory and inhibitory modulatory inputs increase, there is no major net effect on membrane potential, but the increasing synaptic conductance will lower neuronal input resistance and render driver inputs less effective; this is a form of gain modulation (Chance et al., 2002). That is, the lower input resistance due to the increased synaptic conductance would mean that driver EPSP amplitudes were reduced. Because activation of cortical axons can in many cases lead to a conjoint increase in excitation (through direct inputs) and inhibition (through activation of reticular cells or interneuron), the corticothalamic pathway may also play such a role in gain modulation. If this were the case, the effect would be that increasing activity in the corticothalamic axons would lead to reduced synaptic efficacy of driver inputs to relay cells.

An example of how this might operate comes again from the lateral geniculate nucleus; this would serve as a mechanism for contrast gain control. Higher contrast in the retinal image leads to increased firing of retinal axons, and this in turn leads to increased firing levels in geniculate relay cells. If the firing becomes too high and approaches saturation, the relay becomes nonlinear and can no longer signal further increases in input firing levels. However, this very increase in firing of relay cells could plausibly lead to increased activity in the target cortical area, including the corticogeniculate feedback. The increased firing in the feedback would serve, as indicated in the preceding paragraph, to reduce the gain of the retinogeniculate synapse, thereby down-regulating the sensitivity of the relay and keeping it in its linear range.

## DRIVERS AND MODULATORS

It is clear when we look at the innervation of relay cells that a wide variety of inputs is present, and they represent quite different functions. This is clearest for relay cells of the lateral geniculate nucleus, and we will look at this nucleus to explore part of the functional significance of these different inputs. We know that the function of geniculate relay cells is to transfer retinal information to cortex, yet retinal input represents only a small fraction of all synapses found on these relay cells. If retinal input is what is being relayed, and can be set apart, what are the other inputs doing?

One of the main reasons that we know retinal input is being relayed is that it is necessary and sufficient for the receptive fields of geniculate relay cells, and these receptive fields indicate the sort of information being relayed to cortex. There are two parts to this. First, the receptive fields of retinal ganglion cells innervating the lateral geniculate nucleus are virtually the same as those of the relay cells (reviewed in Lennie, 1980; Sherman, 1985), which in turn are quite unlike the receptive fields of nonretinal inputs, such as those from cortex or brainstem (e.g., Gilbert, 1977; Murphy et al., 1999). Second, removing cortical (Gilbert, 1977; Murphy et al., 1999) or brainstem (Meulders and Godfraind, 1969; Wróbel, 1981) inputs to relay cells has only quite subtle effects on geniculate receptive fields, whereas removing retina necessarily obliterates them. We have referred to the input to thalamus that brings the information to be relayed as the *driver* input, and all others as *modulatory* input, with the latter serving to

modulate thalamic transmission of driver input. Drivers and, by elimination, modulators can also be readily recognized for the main somatosensory and auditory thalamic relays on the basis of functional arguments parallel to those presented for the visual pathways, and also on the basis of the common light and electron microscopic structures and relationships of these several drivers.

However, assignment of various inputs to these classes in many thalamic relays is less clear and must be based on incomplete evidence. One approach here is to look at other differences between drivers and modulators in the lateral geniculate nucleus and, where known, also in the ventral posterior nuclei and ventral portion of the medial geniculate nucleus. These are as follows (for details, see Sherman and Guillery, 1998):

1. Driver (retinal) inputs to relay cells provide the main receptive field properties and are necessary for the existence of the receptive fields, whereas modulator inputs induce only subtle changes in receptive field properties.
2. Driver inputs end in RL terminals, which, as noted earlier, are by far the largest in the neuropil, and each typically provides several different contact zones onto the same postsynaptic profile. This might help explain the great synaptic strength of drivers. The smaller modulator terminals seldom have more than one synaptic contact zone each. Driver inputs vary in their relationships to interneurons but otherwise show essentially the same structure throughout the thalamus.
3. Despite the small number of driver synapses, driver EPSPs are relatively large, suggesting relatively strong synapses.
4. Driver inputs provide a minority of synapses to relay cells (only 5%–10% come from retina).
5. Driver terminals are limited to proximal dendrites and often form triadic synaptic arrangements in glomeruli, whereas modulator terminals can be found anywhere on the dendritic arbor.
6. As a general rule, inhibitory inputs make poor drivers (Smith and Sherman, 2002), and thus drivers are all likely to be excitatory (and probably glutamatergic).
7. Driver inputs activate only ionotropic glutamate receptors, whereas modulator inputs can activate metabotropic receptors and often also ionotropic receptors; this means that drivers do not act slowly, a point elaborated later.
8. There is relatively little convergence of driver inputs, so that, for instance, geniculate relay cells receive most retinal synapses from one to three axons, whereas the number of corticogeniculate axons converging onto a relay cell is at least an order of magnitude greater and probably very much greater than that.
9. As a result of many of these points, the *cross-correlogram* (the probability of a spike in the postsynaptic cell for each spike in the presynaptic axon) has a relatively sharp, narrow peak for driver inputs but not for modulator inputs.
10. Driver inputs do not innervate the thalamic reticular nucleus, whereas modulator inputs do.

These criteria cannot usually be applied to all thalamic relays: for instance, it is not clear how the receptive field criterion might be applied to nonsensory relays. However, other criteria, such as the size of afferent terminals, the location of terminals in the dendritic arbor, whether the thalamic reticular nucleus is innervated by collaterals, and

the nature of associated postsynaptic receptors, can give clues as to which set of afferents to a thalamic relay might be the drivers.

The fact that driver inputs activate only ionotropic receptors has several important functional implications. Consider retinal inputs, for example. They will activate only ionotropic glutamate receptors, ensuring a relatively fast, short duration EPSP. This permits fast changes in the spike pattern of the retinal afferents to be encoded in the pattern of EPSPs. If, instead, retinal axons were to activate metabotropic glutamate receptors, the sustained EPSP would serve to obscure fast changes in the afferent firing rate, acting like a low pass temporal filter that eliminates higher frequency information. Thus the lack of metabotropic glutamate receptors at the retinogeniculate synapse helps to ensure a wider range of temporal information in the relay to cortex. However, this also means that the fast EPSPs evoked would not serve well to control neuronal voltage-dependent properties with longer time courses, such as  $I_T$  underlying the burst firing mode; as noted earlier, such properties are better controlled by modulators and their activation of metabotropic receptors.

Another important point in this distinction between drivers and modulators can be seen in numbers. The relatively small numbers of drivers means that it does not require the large synaptic numbers characteristic of a thalamic relay to convey the basic information carried by a sensory or other driver pathway. However, the large number of modulator synapses is in keeping with the many forms of subtle modulation of thalamic relays these inputs perform. Furthermore, there is a lesson here that numbers alone can be misleading. That is, if only the anatomical numbers of inputs to geniculate relay cells were known, the roughly one-third that come from the parabrachial region would seem huge compared with the 5%–10% from retina, with the likely result that one would be tempted to conclude that the lateral geniculate nucleus relays parabrachial, and not retinal, information to cortex. The point is that it is not the quantity of the input that counts but rather its nature, particularly with regard to driver versus modulator function.

Finally, this driver/modulator distinction may apply beyond thalamus and perhaps into cortical circuitry as well. For instance, the geniculocortical synapse has many of the above features of a driver (Ahmed et al., 1994, 1997; Reid and Alonso, 1995, 1996; Stratford et al., 1996): large axons and terminals; small synaptic numbers (only 6% of synapses on layer 4 cells derive from geniculate axons, a number suspiciously close to the contribution of retinal inputs to the synapses on geniculate relay cells); synaptic location on proximal dendrites; large EPSPs, relatively little convergence, and cross-correlograms with a sharp, narrow peak. This is considered further in the next section.

## FIRST ORDER AND HIGHER ORDER RELAYS

We indicated in the introduction that there is a basic distinction between first order and higher order relays. Higher order relays receive driving afferents from cells in layer 5 of the cerebral cortex, whereas first order relays receive their driving afferents from a variety of noncortical sources. Figure 8-1 shows the thalamic nuclei that represent first order relays and those that are entirely or predominantly higher order. Two points should be noted. One is that this classification applies to specific thalamic relays, rather than to thalamic nuclei. Although there are nuclei like the lateral geniculate nucleus or the

ventral part of the medial geniculate nucleus that are essentially pure first order relays, there are also reasons for believing that in many nuclei one will find a mixture of first and higher order relays. The second point is that "first order" refers to the fact that these relays transmit information that is on its way to the cortex for the first time. We have used "higher order" rather than "second order" because many of the corticothalamic drivers that innervate the higher order relays will be representing loops that are bringing messages for a third or fourth or higher order re-presentation to cortex.

The nuclei that are not shaded in Fig. 8-1 were long regarded as "association nuclei." This was not because anyone had traced pathways that might serve to provide the implied sensory associative functions; it was camouflage for ignorance. No one knew what sort of messages these nuclei might be transmitting to cortex, even though for most of them the general details of the thalamocortical projection pattern had been well defined (e.g., Walker, 1938). The first indication that the driving afferents to these nuclei might be coming from cortex rather than from other diencephalic centers came from the demonstration that in the monkey pulvinar region the RL terminals, which correspond to the drivers in first order nuclei (see *The Electron Microscopic Appearance of the Neuronal Elements*) degenerated after lesions of visual cortex (Mathers, 1972). Further autoradiographic and degeneration studies confirmed this for the pulvinar region (Robson and Hall, 1977; Ogren and Hendrickson, 1979) and also for a pathway from frontal cortex to the mediodorsal nucleus in monkey (Schwartz et al., 1991). More evidence came from an electrophysiological demonstration of a corticocortical pathway linking visual cortical areas through the lateral posterior nucleus of the cat (Kato, 1990). Light microscopic evidence about the structure of the driver afferents to higher order relays did not become available until it was possible to fill single axons, or small groups of axons, and identify the structure of the terminals in the thalamus, thus distinguishing type 1 from type 2 axons (see Fig. 8.6). It then appeared that injections of cells in layer 5 of cortex produced labeled axons having the appearance of type 2 axons (Hoogland et al., 1991; Deschênes et al., 1994; Ojima, 1994; Rockland, 1996), whereas injections in layer 6 produced labeled axons having the appearance of type 1 axons. The former match the structure of the (ascending) drivers of first order relays and do not go to first order relay nuclei like the lateral geniculate nucleus, whereas the latter correspond to the corticothalamic modulators found in first order relays and are represented in all thalamic nuclei. It is important to note that in many instances the type 2 axons from layer 5 have a strictly localized thalamic terminal distribution, showing a far more limited terminal field than the type 1 axons coming from layer 6 of the same cortical column (Bourassa et al., 1995; Darian-Smith et al., 1999; Guillery et al., 2001). This is in contrast to a recent claim that the layer 5 afferents have diffuse thalamic terminals (Jones, 2002).

The evidence about the origin of the layer 5 and layer 6 corticothalamic axons was in accord with observations of retrogradely transported label. That is, injections of the first order relays marked cortical cells in layer 6 only but marked cells in layers 5 and 6 after injections into higher order relays (Gilbert and Kelly, 1975; Abramson and Chalupa, 1985).

Apart from the details of their synaptic organization that were considered earlier, there are two further telling parallels between the ascending drivers to first order nuclei and the corticothalamic drivers to higher order nuclei. Neither has branches with

terminals in the thalamic reticular nucleus, and both very commonly have branches that innervate lower levels of the brain stem or spinal cord (see *How Does the Thalamus Relate to Motor Outputs?*).

We have indicated that one important distinction between drivers and modulators is that silencing the drivers abolishes the characteristic receptive fields of thalamic relay neurons, whereas silencing the modulators does not. That is, for the lateral geniculate nucleus, destruction or silencing of visual cortex produces subtle changes in receptive field properties, but the visual receptive fields survive. This is in contrast to silencing retinal ganglion cells, which produces a complete loss of geniculate receptive fields. The same argument can be applied to higher order nuclei. Recordings from thalamic relay cells in two higher order relays (the pulvinar region of the monkey and the posterior nucleus of the rat) have demonstrated that lesions of the cortical areas that provide layer 5 (type 2) afferents to the relay cells produce a loss of receptive fields, comparable to the loss seen in first order relays after removal of the ascending driver afferents (Bender, 1983; Chalupa, 1991; Diamond et al., 1992).

The receptive field properties that have been reported for cells in the pulvinar region resemble those of cells in layer 5 of visual cortex, further supporting the idea that the layer 5 cells provide the driving input to the pulvinar cells. However, the situation is complicated because there are several separate cortical areas that provide driving afferents to any one small area of the pulvinar region (Guillery et al., 2001), and it is reasonable to expect each area to provide somewhat different functional properties to the pulvinar cells. That is, cells in the pulvinar region receiving from layer 5 inputs that come from different cortical areas and have distinct functions are likely to be intermingled, as are X cells and Y cells in the A layers of the cat's lateral geniculate nucleus. For anesthetized animals, there are reports of cells with receptive field properties resembling those of area 17 (Chalupa and Abramson, 1989; Merabet et al., 1998; Casanova et al., 2001) or of cortical area MT (Merabet et al., 1998). For awake behaving monkeys, there are reports of cells resembling cells in cortical area 5a that respond for reaching movements of the hand (Cudeiro et al., 1989; Acuña et al., 1990). Tellingly, in the relevant part of the pulvinar only about 16% show this property, indicating that there are other cells with different properties in the same region, and suggesting that, perhaps, if each functionally distinct class represents only about 16% of the cells, then there is room for a significant number of functionally distinct classes. The issue of whether there is any interaction among pathways in the pulvinar region, involving elaboration of receptive field properties, or whether, like the lateral geniculate nucleus, the pulvinar cells provide independent straight through pathways to cortex remains to be defined.

The recognition of corticothalamic driver afferents to higher order relays has vitally important implications for our understanding of thalamocortical and corticocortical relationships and functions (Guillery, 1995; Sherman and Guillery, 1998, 2001, 2002; Guillery and Sherman, 2002a). The thalamus is no longer seen as essentially just a relay for ascending messages to reach the cortex, with all subsequent cortical processing carried out by a complex array of hierarchical and parallel corticocortical pathways as shown in Fig. 8.17A (Felleman and Van Essen, 1991; Van Essen et al., 1992; Purves et al., 1997; Kandel et al., 2000). Instead, recognition of transthalamic corticocortical pathways through higher order thalamic relays introduces an array of novel connec-

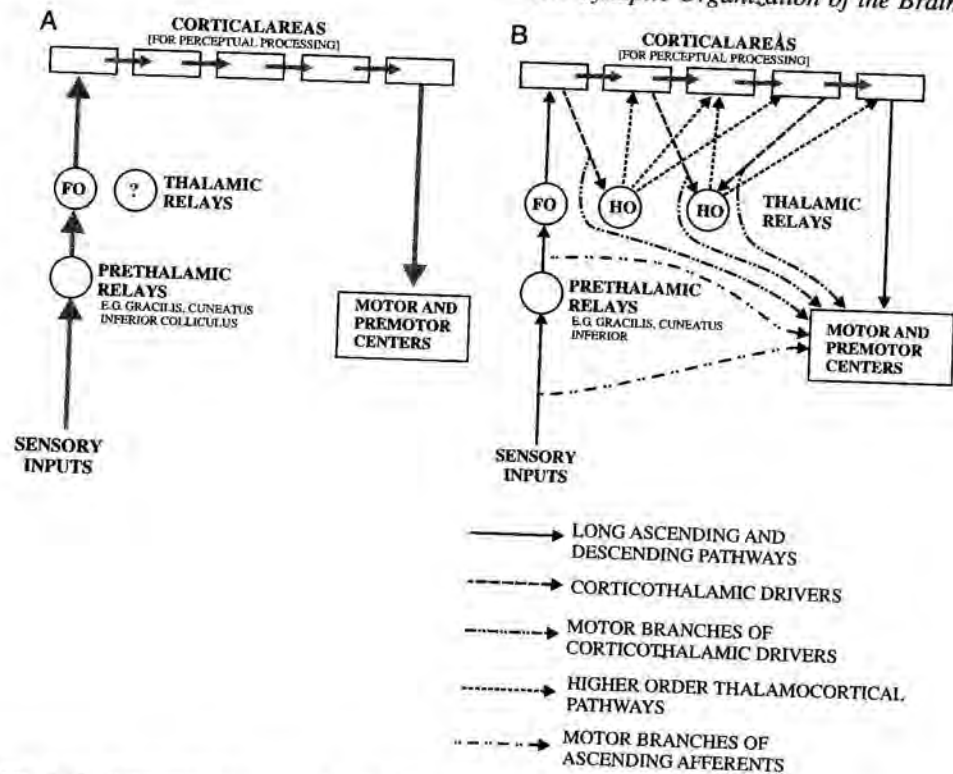

Fig. 8.17. Schematic representation of thalamocortical relationships. **A:** Conventional view of thalamocortical processing in relation to motor outputs. **B:** Connections documented here, showing the transthalamic corticocortical pathways and the connections to motor centers at all levels of the classic sensory pathways. Abbreviations: FO, first order relay; HO, higher order relay. Further details in the text.

tions through which one cortical area can communicate with another (Fig. 8.17B). Each of these transthalamic corticocortical pathways will be subject to the modulatory influences that play such a dominant role in the synaptic organization of thalamic relays. That is, for each transthalamic corticocortical pathway, there will be opportunities for cortical and for brainstem modulatory influences as well as for local inhibitory influences to act.

Every area of neocortex receives afferents from the thalamus. For primary receiving areas like visual, auditory, or somatosensory cortex, we can claim a fair understanding of the nature of the thalamic inputs, and it is easy to appreciate that the dominant, or only, function of these cortical areas is the processing of information that comes from the thalamus. The possibility that the same holds for other cortical areas has not been explored. In fact the thalamic inputs to these other areas are generally ignored as experiments that concern perceptual processing or movement control are studied.

## HOW DOES THE THALAMUS RELATE TO MOTOR OUTPUTS?

The relationship of the thalamus to sensory mechanisms at first sight looks relatively straightforward. Messages from each of the major classes of sensory receptor pass through the first order thalamic relays and onto primary receiving areas of the cortex, being exposed to the modulatory inputs discussed earlier. From there, on the view of intracortical perceptual processing discussed earlier (see Fig 8.17A), the sensory messages are passed through a hierarchical series of cortical areas with no further thalamic modulation and then are passed to areas concerned with motor outputs. On the transthalamic view of perceptual processing, the messages are passed to other cortical areas through one or more higher order thalamic relays and are subject to modulatory influences at each pass through the thalamus. The transthalamic pathways also introduce an important link between sensory and motor pathways that is not represented in the intracortical pathways. This link is provided by the driver afferents to thalamus that come from layer 5 of cortex, because, as we have seen, these afferents also have long descending axons, and these innervate motor or premotor structures. There are two ways of viewing this link. One is that at each stage of the transthalamic pathway the motor system receives inputs that relate to the ongoing perceptual processing. A second is that the transthalamic pathway for perceptual processing is based on corticothalamic driver messages from layer 5 that represent copies of motor instructions. These are not mutually exclusive mechanisms; they are alternative ways of interpreting the same close functional links between the sensory and the motor systems.

These links not only can be seen in the higher order thalamic relays involved in the transthalamic corticocortical pathways but are also well represented in the first order thalamic relays that carry messages to primary receiving areas of cortex. The evidence concerning the motor links of driving afferents to the thalamus, which was reviewed in detail (Guillery and Sherman, 2002b), will be briefly summarized, first for first order thalamic relays and then for the higher order relays.

### MOTOR LINKS OF FIRST ORDER AFFERENT DRIVERS

These are well illustrated by the visual pathways, where one finds that most or all of the retinal afferents that go to the lateral geniculate nucleus also send a branch to the superior colliculus or the pretectum. For rodents and rabbits, the evidence that all of the retinogeniculate axons are branches of axons that also go the midbrain is strong (Chalupa and Thompson, 1980; Vaney et al., 1981; Jhaveri et al., 1991). For the cat, there is wide agreement that the Y cells and W cells all send branches to the midbrain (Fukuda and Stone, 1974; Wässle and Illing, 1980; Leventhal et al., 1985), but the branching pattern of the X cells has proved somewhat more difficult to demonstrate because these cells send quite thin branches to the pretectum, which have been demonstrated by intracellular injections of relatively small tracer molecules (Tamamaki et al., 1994). These studies of the retinopretectal branches of X cells in the cat lead to two important conclusions. One is that in the cat all retinogeniculate axons are likely to be branches of axons that also innervate the midbrain, and the second is that negative evidence about the presence of a branch cannot be interpreted as evidence for the absence of such a branch. The methods that are available, whether anatomical or phys-



iological, are not sufficiently robust to allow any interpretation of a negative result (see also Lu and Willis, 1999). The evidence for the monkey shows that the magnocellular and koniocellular pathways have branches that go to the midbrain. The evidence for the parvocellular pathways is less clear, although the occasional report of a midbrain connection suggests that these may be like the cat's X cell axons—present but thin and difficult to demonstrate.

In the past the retinotectal branches were often viewed as an alternative, extrageniculate pathway to the cerebral cortex, reaching extrastriate cortical areas along tectopulvinocortical connections (Sprague, 1966, 1972; Schneider, 1969; Sprague et al., 1970; Diamond, 1973). This view of the tectal connections cannot be entirely ruled out, but it is relevant that receptive fields of cells in the pulvinar region are lost after lesions of visual cortex but are not lost after lesions of the tectum. That is, the cortical inputs to the pulvinar region are more likely to be the drivers than are the tectal inputs. No matter what may be the action of the tectal pathway on the pulvinar cells, the input to the superior colliculus and pretectum must produce some change in these motor centers themselves, and that is the point that is relevant for appreciating that activity in the retinogeniculate pathway will almost invariably be accompanied by activity in the pathways to the midbrain.

Evidence for other first order relays also shows that many of the axons going to the thalamus have branches going to lower, motor centers, or else the cells that give rise to these axons are innervated by axons that have such branches. The anterolateral pathways concerned with pain and temperature give off many branches at the level of the spinal cord and play a significant role in spinal reflexes before they reach the thalamus (Lu and Willis, 1999). The axons of the dorsal roots that enter the posterior columns and contribute to the spinal levels of the lemniscal pathways similarly have many intraspinal branches. At the next synaptic relay in the posterior columns and lateral cervical nucleus, there are many cells that contribute to centers other than the thalamus, several of them doing so via branches of the axons that also go to the thalamus (Berkley, 1975; Craig and Burton, 1979; Feldman and Kruger, 1980; Djouhri et al., 1997). Similarly, there is evidence that axons going from the deep cerebellar nuclei to the ventrolateral nucleus also send branches to the brain stem (Cajal, 1911; Tsukahara et al., 1967; Shinoda et al., 1988), and the axons that come from the mamillary bodies and innervate the anterior thalamic nuclei also have branches that travel in the mamillothalamic tract to regions of the brain concerned with eye movement control and vestibular mechanisms (Kölliker, 1896; Cajal, 1911; Guillery, 1961; Torigoe et al., 1986). There is only limited information about the details of branching patterns in the auditory pathways, but it is relevant to note that the inferior colliculus, which sends driver afferents to the medial geniculate nucleus, also sends afferents to the superior colliculus (Harting and Van Lieshout, 2000).

#### MOTOR LINKS OF HIGHER ORDER AFFERENT DRIVERS

Evidence that corticothalamic axons from layer 5 pyramids that innervate higher order thalamic relays are branches of axons that also pass to lower centers in the brainstem comes from injections that label single cortical cells or small groups of cortical cells and that allow the individual axons to be traced through the thalamus. Several studies, including studies in cat, rat, and monkey, of pathways involving visual and so-

matosensory systems (Bourassa et al., 1995; Bourassa and Deschênes, 1995; Rockland, 1996) have demonstrated that the axons from layer 5 have thalamic branches with characteristic well localized thalamic terminals that look essentially like retinal or lemniscal terminals. Like these other driver afferents, they do not send branches to the thalamic reticular nucleus, but they commonly, possibly always (Guillery et al., 2001), have long descending branches that go to the midbrain or pons or farther caudally. Currently, we know very little about the functional properties of the cells that come from layer 5, especially in regard to the possible actions of the long descending pathways. It is possible that knowledge about the role of these long descending axons would help to illuminate the nature of the message that is being sent to the higher order relays in the thalamus.

#### RELATIONSHIPS OF SENSORY PERCEPTION TO MECHANISMS OF MOTOR CONTROL

The axons that provide driver afferents for the thalamus from the cerebral cortex or from lower centers cannot be considered as providing a dedicated *sensory* line from periphery or from cortex to the appropriate thalamic nucleus. Instead, they all, or almost all, represent a system that is concurrently feeding the same information to the thalamic relay and to one or another center concerned with *movement control*. When the thalamic pathways are viewed in this light, the messages passing through the thalamus to cortex for perceptual processing can be seen as providing information to cortex about how the body is currently being prepared to react to sensory inputs. The information that is classically treated as "sensory" information, providing the cortex with information about what is really out there in the perceived world, is also information that is serving to control the organism's immediate responses, and this may be of primary relevance for the survival of the organism (Guillery, 2003).

#### SUMMARY

It has long been clear that the thalamus plays a crucial role in information transfer to cortex. Evidence shows that, in addition, it is an important part of ongoing communications between cortical areas. This puts the thalamus at the very core of cortical processing. Furthermore, the information, whether ascending or corticocortical, is not relayed through the thalamus in a simple, passive, machine-like manner, but rather is a complex process that keeps the nature and extent of information transfer under dynamic control. The complexity is evident in the fact that a vast majority of synaptic inputs to relay cells do not come from the drivers, the main source of information to be relayed to cortex, but from modulatory sources, including, among others, inputs from local GABAergic cells, inputs from cortex, and inputs from the brainstem. Further, there is increasing evidence that for most, possibly all, thalamic relays, the message that is relayed, whether from the periphery through a first order thalamic relay or from one cortical area to another through a higher order relay, comes from a branching axon that is concurrently sending the same message to motor centers. This in turn suggests that all thalamocortical relays, even the classic "sensory" relays like the lateral geniculate nucleus, function to provide to the cortex not so much a picture of the world that is thought to be represented in the sensory pathways but rather a constant updating of motor commands that are currently being issued at many different levels in response to the sensory inputs.

## BASAL GANGLIA

CHARLES J. WILSON

The basal ganglia are a richly interconnected set of brain nuclei found in the forebrain and midbrain of mammals, birds, and reptiles. In many species, including most mammals, the forebrain nuclei of the basal ganglia are the most prominent subcortical telencephalic structures. The large size of these nuclei, and their similarity in structure in such a wide range of species, make it likely that they contribute some very essential function to the basic organizational plan of the brain of the terrestrial vertebrates. However, the assignment of a specific functional role for the basal ganglia has been difficult, as it has for other brain structures that have no direct connections with either the sensory or motor organs.

The most widely accepted views of basal ganglia function are based on observations of humans afflicted with degenerative diseases that attack these structures. In all cases these diseases produce severe deficits of movement. None of the movement deficits is simple, however, or easily described. In some, such as Parkinson's disease, movements become more difficult to make, as if the body were somehow made rigid and resistive to changes in position. In others, such as Huntington's disease, useless and unintended movements interfere with the execution of useful and intended ones. In general, these symptoms affect only voluntary, purposive movements, with reflexive movements being relatively unaffected. These observations have led most clinical investigators to view the basal ganglia as components of a system that is somehow involved in the generation of goal-directed voluntary movement but in complex and subtle aspects of that process. Current views based on experimental studies suggest a more general role for the basal ganglia in selection among candidate movements, goals, strategies, and interpretations of sensory information. In such views, the basal ganglia make these selections based on the past history of success under similar circumstances.

The anatomical connections of the basal ganglia link it to elements of the sensory, motor, cognitive, and motivational apparatus of the brain. These connections are best appreciated within the context of the arrangement of the several nuclei that make up the basal ganglia. A diagram showing the arrangement of the most prominent of these nuclei as they appear in a frontal section of the human brain is shown in Fig. 9.1. The major structures are the caudate nucleus, putamen, globus pallidus (GP), substantia nigra, and subthalamic nucleus. Also seen in the diagram are the two largest sources of input to the basal ganglia: the cerebral cortex and the thalamus.